

GAME 1162-E  
SERVICE MANUAL  
FO 635

*Dolly*



*Bally*

MANUFACTURING CORPORATION

2840 Belmont Avenue - Chicago, Illinois 60618, U.S.A.

TELEPHONE (312) 357-1400 TELEFAX (312) 207-1144 FAX (312) 357-1400

© 1987 BALLY MANUFACTURING CORPORATION  
ALL RIGHTS RESERVED

Installation and General Game Operation Instructions

INDEX

	PAGE
I. INSTALLATION .....	1
II. GENERAL GAME OPERATION .....	2
III. BOOKKEEPING FUNCTIONS .....	3
IV. FEATURE OPERATION AND SCORING .....	4
V. GAME ADJUSTMENTS .....	5
A. PLAYFIELD ADJUSTMENTS .....	5
B. BACKBOX ADJUSTMENTS .....	5
CREDITS/COIN .....	5
MAXIMUM CREDITS .....	6
BALLS/GAME .....	6
MATCH FEATURE OPTION .....	6
CREDIT DISPLAY .....	6
HIGH SCORE FEATURE OPTION .....	6
HIGH SCORE TO DATE .....	6
GAME FEATURE OPTIONS .....	7
SOUND OPTION .....	7
C. FRONT DOOR GAME ADJUSTMENTS	
HIGH SCORE FEATURE .....	8
HIGH SCORE TO DATE FEATURE .....	8
VI. RECOMMENDED SCORE CARDS .....	11
VII. RECOMMENDED SETTINGS .....	12
VIII. ROUTINE MAINTENANCE ON LOCATION .....	13
IX. TROUBLE SHOOTING ON LOCATION .....	13
X. SERVICE/PARTS .....	19
XI. PARTS LIST .....	20-30

# BLOCK DIAGRAM—ELECTRONIC PINBALL GAME

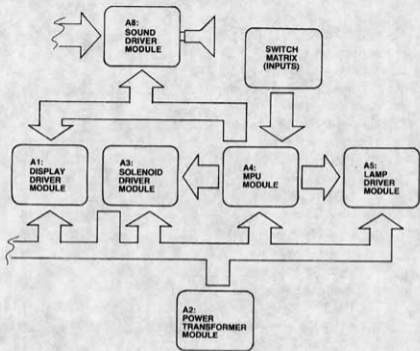

## I. INSTALLATION

### Assemble the game as follows:

Bolt legs to cabinet. Bolt back box to cabinet. Use flat washers under bolt heads. Gently feed cable connectors and ground braid through cable port in back box. Screw ground braid to braid in back box. Carefully and fully insert connectors on printed circuit assemblies.

On all games there are certain items that should be checked after shipment. These are visual inspections which may avoid time consuming service work later. Minor troubles caused by abusive handling in shipment are unavoidable. Cable connectors may be loosened, switches (especially tilt switches) may go out of adjustment. Plumb bob tilt switch should always be adjusted after game is set on location and leg levelers are adjusted.

### Visual inspections before plugging in line cord:

1. Check that all cable connectors are completely seated on printed circuit assemblies.
2. Check that cables are clear of all moving parts.
3. Check for any wires that may have become disconnected.
4. Check switches for loose solder or other foreign material that may have come loose in shipment and could cause shorting of contacts.
5. Check wires on coils for proper soldering. Cold solder connections may not show up in factory inspection, but vibration in shipment may break contact.
6. Check that fuses are firmly seated and making good contact.
7. Check the transformer for any foreign material shorting across wiring lugs.
8. Check wiring of transformer to correspond to location voltage. See figure 1.

### Check adjustment of the three (normally open) tilt switches:

1. Panel tilt on bottom of playfield panel.
2. Plumb bob tilt on left side of cabinet near front door.
3. Ball tilt above plumb bob tilt. Insert the smaller ball (15/16" dia.) into the ball tilt assembly, and adjust the bracket so the ball will roll free to contact the switch blade, if front of cabinet is raised.

### TRANSFORMER CONNECTION INSTRUCTIONS

E-122-125 TRANSFORMER WIRING FOR 225/240 V.,  
50/60 CYCLE INPUT.

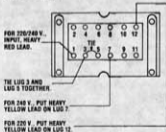

VARISTOR, BALLY PART NO. E-713-1,  
LOCATED IN CABINET, MUST BE USED  
FOR OPERATION AT 225 V. OR 240 V. A.C.

E-122-125 TRANSFORMER WIRING FOR 115/120 V.,  
50/60 CYCLE INPUT.

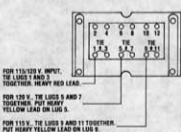

VARISTOR, BALLY PART NO. E-713,  
LOCATED IN CABINET, MUST BE USED  
FOR OPERATION AT 115 OR 120 V.A.C.

FIGURE I. TRANSFORMER  
(PART OF POWER—TRANSFORMER MODULE A2, LOCATED IN BACK BOX).

## II. GENERAL GAME OPERATION

### Place ball into playfield by outhole.

**Coin game.** Coin should be rejected. Plug in line cord. Move power ON-OFF master switch at bottom right front corner of cabinet to 'ON' position. The game will play a power-up tune to announce game-readiness. Drop targets are reset, scores are set to zero, alternating with the 'High Score to Date', and the game is ready for play. Coin game. The game should accept the coin and post credits\* for coins accepted (adjustable). Pressing the credit button on the door will cause the outhole kicker to serve the ball to the shooter alley. The 1st player-up lite is lit. A game-up tune\* is played to announce play-readiness. The bonus score is advanced to 1000 points.

One player is posted each additional time the credit button is pressed (one to four can play). The credits are reduced by one each time the credit button is pressed until the credits are reduced to zero.

Shooting the ball initiates play. Rebound switches score 10 points. Thumper-bumpers, when not lit, score 10 points.

The game awards all points earned by the player. If spinner is turning and scoring when the ball hits a target, the spinner and the target scores are awarded.

When the ball enters the outhole, the bonus score is added to the total score. The player-up and/or ball in play on the back box is advanced one position. The bonus score is advanced to 1000 points. The outhole kicker serves the ball to the shooter alley and play is resumed. This continues until each player has played the allowable number of balls per game (adjustable). At this time the 'Game Over' light is lit. A random Match\* number appears and the 'Match' light is lit. If the number is the same as the last two digits in a player's score, a free game is awarded.

Extra balls won during the course of the game are played immediately after the player's regular ball enters the outhole. The player-up and/or ball in play on the back box are not advanced for extra ball play. Bonus score is added to the player's score and the bonus is set to 1000 points before the game serves the extra ball for play.

Scoring over 1,000,000 gives "High Score to Date" award.

At the end of the game, a 'High Score to Date' is alternately flashed with all 4 player scores. If the 'High Score to Date' is beat, this feature\* awards free games.

Tilting the game results in loss of a ball. The flippers, thumper-bumpers, etc., go 'dead.' Bonus points are not scored. The purpose of the tilt penalty is to discourage the player from jostling the machine in an attempt to prolong play. Game action becomes normal after the ball kicker assembly serves the ball to the shooter alley.

Slamming the machine results in loss of the game. All feature lights go out, the game goes 'dead,' and a time delay occurs. The purpose of the time delay is to discourage unnecessary abuse of the machine. After the delay, the 'Game Over' light lites and the power-up tune is played. The time delay occurs anytime one of the slam switches is made to contact. There is one factory installed slam switch on the front door. (Any number of slam switches could be installed by the operator, to meet his individual requirement.) The switch should be adjusted to have approximately 1/16" gap between the contacts. The weighted blade should be adjusted to attain the desired sensitivity. Decreasing the gap between contacts will make the switch more sensitive. Opening the gap will reduce sensitivity.

\*Some tunes and features can be disabled by operator if so desired. See Back Box Adjustments.

### III. BOOKKEEPING FUNCTIONS

The game is designed to help the operator certain perform accounting functions. The game can display the number of total plays and replays (free games). It can display the number of coins dropped down each coin chute. The bookkeeping functions are displayed on all player score displays simultaneously. An identification number, 05 to 14, appears on the Match/Ball in Play window as follows:

- 05— 00 to— 40 = Current Credits
- \*06— 10000 to—99999 = Total Plays (Payed & Free Games)
- \*07— 10000 to—99999 = Total Replays (Free Games)
- 08— 00 to—99999 = Total times 'High Score to Date' is beat
- \*09— 10000 to—99999 = Coins Dropped thru Coin Chute #1
- \*10— 10000 to—99999 = Coins Dropped thru Coin Chute #2\*\*
- \*11— 10000 to—99999 = Coins Dropped thru Coin Chute #3\*\*
- \*12— 00 to—99999 = Number of Specials awarded from Panel Specials Only
- \*13— 00 to—99999 = Number of minutes of Game Play
- \*14— 00 to—99999 = Number of Service Credits

The game displays the first bookkeeping entry if the Self-Test button (See Fig. III) on the inside of the front door is pressed ten times. Alternately push and release the Self-Test button at one second intervals. The number 05 appears in the 'Match/Ball in Play' window. Current credits appear on the player score displays. Each additional press of the button causes the next entry to be displayed.

After the data in each bookkeeping register is recorded, it can be set to zero simply by pressing switch button S33, located on A4, the MPU module in the back box (See Fig. III), or by pressing the Coin Chute #3 switch. Any or all registers can be cleared by alternating between the Self-Test button and the switch button S33 on the MPU module or Coin Chute #3 switch. The operator is given this option as a possible convenience and can elect to use or not use it as his needs direct.

Pressing the button once more with the 14th entry displayed causes the game to play the power-up tune and light the Game Over light.

Service credits are designed to allow the serviceman to test the game under actual play conditions without disturbing the bookkeeping records that reside at identification numbers 06, 07, 09, 10 and 11.

To obtain Service Credits, push and release the Self-Test switch until identification number 05 appears in the 'Match/Ball in Play' window. Hold in the Credit button until the desired number of Service Credits (up to five) appears on the player score displays.

NOTE: If, upon accessing identification number 05, a number of credits greater than five is displayed, pressing the credit button has no effect.

Identification number 14 is reserved as a record of the number of Service Credits used.

\*The 10,000 level is pre-set at the factory; can be set to zero, initially, if desired.

\*\*If Coin Chute is not used in game, number displayed (if other than 00) on Player Score displays has no significance.

**DOLLY PARTON**  
**#1162-E**  
**FEATURE OPERATION & SCORING**

**A. TOP SAUCER FEATURE: (Parton)**

Each time the ball goes into the top saucer 500 points are scored and the letter that is lit there is spotted at the center of playfield. When all the letters of P-A-R-T-O-N are spotted, top saucer 5,000 point lite will come on to score 5,000 points.

5 left top Dolly targets will spot Dolly in center of playfield when each is hit respectively. When all the D-O-L-L-Y letters are spotted 1K lite by targets will lite to increase the value of targets from 400 points to 1000 points when hit.

**DOLLY PARTON BONUS FEATURE**

A. When DOLLY PARTON is made first time 22,000 points and 2 return lane lites for 5,000 points. (see SW. option for lib and cons position).

When DOLLY PARTON is made second time 44,000 points, and 2 outline specials and Dolly Parton special lites. (see SW. option for lib and cons position).

When DOLLY PARTON is made third and each additional time, one replay is awarded.

**4 DROP TARGET INLINE FEATURE:**

A. First target down scores 200 points. Lites spinner for 1,000 points and spots top PARTON (lit letter).

B. Second target down scores 400 points lites 2X bonus and spots top PARTON (lit letter).

C. Third target down scores 600 points lites 3X bonus and spots top PARTON (lit letter).

D. Fourth target down scores 800 points lites extra ball pot, 5X bonus and spots top PARTON (lit letter).

E. Last target first time hit scores extra ball second time special replay, 3rd and each additional time 20,000 points.

**B. BONUS SCORE FEATURE**

Each lit letter in center of playfield (Dolly Parton) is valued at 2,000 points times multiplier (if lit) when ball enters outhole.

The 2X, 3X, 5X multiplier has a recall SW. option.

**C. RECALL FEATURE**

There is a recall on 22,000 points, 44,000 points and any DOLLY PARTON lites made in center of playfield.

**THUMPER BUMPER FEATURE**

All 3 thumper bumpers are lit and score 100 points each at all times.

**RIGHT CENTER ROLLOVER FEATURE**

Scores 5,000 points at all times and free ball back on shooter gauge.

#### D. SPECIAL REPLAY/X-BALL/NOVELTY MODES

Switch #6 and #7 give the operator flexibility to award a replay, extra ball or score (Novelty) when a special is scored (drop target, PARTON, left or right outline). The following chart explains the settings.

SWITCH	SW. 6 ON	SW. 6 OFF	SW. 6 ON
Positions	SW. 7 ON	SW. 7 ON	SW. 7 OFF
Parton Saucer Special	REPLAY	X-BALL	NOVELTY
Drop Target Special	REPLAY	X-BALL*	50,000
Left or Right Outline Special	REPLAY	X-BALL*	50,000
Drop Target X-Ball	X-BALL	X-BALL**	25,000
Scoring Thresholds	REPLAY	X-BALL**	NO AWARD

(\*) 50,000 if Same Player Shoot Again is lit.

(\*\*) 25,000 if Same Player Shoot Again is lit.



## V. GAME ADJUSTMENTS

### A. Playfield Panel Post Adjustments:

Posts that control left and right outlane opening on panel can be moved to make access to outlanes easier or harder for ball to enter. See Figure II.

Easier entry will decrease playing time and scoring (conservative).  
Harder entry will increase playing time and scoring (liberal).

### B. Back Box Game Adjustments:

Each game has thirty-two switches located on A4, the MPU module, located in the back box, that allow play to be customized to the location. See Figure III. Credits per coin, maximum credits, credit display, balls per game, match feature, high game feature, special award and melody are selectable by means of the switches. The switches are contained in four sixteen lead packages numbered S1-8, S9-16, S17-24 and S25-32 for easy identification. The "ON" toggle position is marked on the assembly. **Turn off power before making adjustments.**

#### Credits/Coin Adjustments:

The credits per coin are selectable by means of S17-S20 for coin chute #2. The switch settings and resultant credits/coin are as follows:

S20	S19	S18	S17	Credits/Coin
OFF	OFF	OFF	OFF	Same as Coin Chute #1 Settings
OFF	OFF	OFF	ON	1/1 Coin
OFF	OFF	ON	OFF	2/1 Coin
OFF	OFF	ON	ON	3/1 Coin
OFF	ON	OFF	OFF	4/1 Coin
OFF	ON	OFF	ON	5/1 Coin
OFF	ON	ON	OFF	6/1 Coin
OFF	ON	ON	ON	7/1 Coin
ON	OFF	OFF	OFF	8/1 Coin
ON	OFF	OFF	ON	9/1 Coin
ON	OFF	ON	OFF	10/1 Coin
ON	OFF	ON	ON	11/1 Coin
ON	ON	OFF	OFF	12/1 Coin
ON	ON	OFF	ON	13/1 Coin
ON	ON	ON	OFF	14/1 Coin
ON	ON	ON	ON	15/1 Coin

The credits given per coin are selectable by means of switches 1-5 incl., for coin chute #1 and switches 9-13 incl., for coin chute #3. Thirty-one different credit ratios are available for each coin chute. The switch settings and resultant credits/coin are listed below.

#### CREDITS/COIN ADJUSTMENTS

COIN CHUTE #1 (HUGE SIDE) OR #3	SWITCHES					CREDITS/COIN
	5	4	3	2	1	
	13	12	11	10	9	
	OFF	OFF	OFF	OFF	OFF	3/2 COINS**
	OFF	OFF	OFF	OFF	ON	3/2 COINS**
	OFF	OFF	OFF	ON	OFF	1/COIN
	OFF	OFF	OFF	ON	ON	1/2 COINS*
	OFF	OFF	ON	OFF	OFF	2/COIN
	OFF	OFF	ON	OFF	ON	2/2 COINS*
	OFF	OFF	ON	ON	OFF	3/COIN
	OFF	OFF	ON	ON	ON	3/2 COINS*
	OFF	ON	OFF	OFF	OFF	4/COIN
	OFF	ON	OFF	OFF	ON	4/2 COINS*
	OFF	ON	OFF	ON	OFF	5/COIN
	OFF	ON	OFF	ON	ON	5/2 COINS*
	OFF	ON	ON	OFF	OFF	6/COIN
	OFF	ON	ON	OFF	ON	6/2 COINS*
	OFF	ON	ON	ON	OFF	7/COIN
	OFF	ON	ON	ON	ON	7/2 COINS*
	ON	OFF	OFF	OFF	OFF	8/COIN
	ON	OFF	OFF	OFF	ON	8/2 COINS*
	ON	OFF	OFF	ON	OFF	9/COIN
	ON	OFF	OFF	ON	ON	9/2 COINS*
	ON	OFF	ON	OFF	OFF	10/COIN
	ON	OFF	ON	OFF	ON	10/2 COINS*
	ON	OFF	ON	ON	OFF	11/COIN
	ON	OFF	ON	ON	ON	11/2 COINS*
	ON	ON	OFF	OFF	OFF	12/COIN
	ON	ON	OFF	OFF	ON	12/2 COINS*
	ON	ON	OFF	ON	OFF	13/COIN
	ON	ON	OFF	ON	ON	13/2 COINS*
	ON	ON	ON	OFF	OFF	14/COIN
	ON	ON	ON	OFF	ON	14/2 COINS*
	ON	ON	ON	ON	OFF	15/COIN
	ON	ON	ON	ON	ON	15/2 COINS*

\*No Credits until second coin is dropped.

\*\*One Credit for first coin. Two Credits for second coin provided that no scoring occurred between 1st and 2nd coin drops. If scoring occurred, second coin gives one credit.

**MAXIMUM CREDITS:**

The maximum credits accepted by the machine limits the number of games that can be accumulated by coining, by winning replays or both. The maximum number of credits is selectable by means of switches 25 and 26. Four credit limits are available. Switch settings are listed below.

MAXIMUM CREDITS	SWITCHES	
	26	25
10	OFF	OFF
15	OFF	ON
25	ON	OFF
40	ON	ON

BALLS PER GAME:	# BALLS/GAME	SWITCH 31
	5	ON
	3	OFF

**MATCH FEATURE:**

When the Match Feature is ON, a random number appears in the Match/Ball in Play window and the word MATCH is illuminated. If the number matches the tens digit in a player's score, a free game is awarded. The Match feature creates an incentive to play.

MATCH	SWITCH 28
ON	ON
OFF	OFF

CREDIT DISPLAY:	CREDITS DISPLAYED	SWITCH 27
	YES	ON
	NO	OFF

**HIGH SCORE FEATURE:**

The game is designed to award an Extra Ball or Free Game at each of the three score levels. See Front Door Game Adjustments.

AWARD	SWITCH 7	SWITCH 6
REPLAY	ON	ON
EXTRA BALL	ON	OFF
NO AWARD	OFF	OFF

**HIGH SCORE TO DATE OR OVER 1,000,000 SCORE FEATURE:**

The game is designed to award free games as an option if high score to date is beat or player exceeds 1,000,000 points. Each time this happens, the winning score becomes the new high score to beat. This score is displayed on all 4 player score displays at the end of each game as an incentive to play. Recommended setting is underlined.

HIGH SCORE TO DATE FEATURE	SWITCH 22	SWITCH 21
No Award	OFF	OFF
One Credit	OFF	ON
Two Credits	ON	OFF
<u>Three Credits</u>	<u>ON</u>	<u>ON</u>

State and local laws may regulate the use of the above features, and they have been designed to allow for appropriate adjustment in order to conform to such requirements.

## #1162 DOLLY PARTON

### SOUND OPTION

The game is designed to play several melodies to announce power-up, game-up, etc. The tunes are intended to attract attention to the game and increase game usage. The tunes are controlled by switch settings as shown below:

	S29	OFF	OFF	ON	ON
	S30	OFF	ON	OFF	ON
POWER UP		NOISE	NOISE	NOISE	NOISE
COIN (NO CREDIT)		NOISE	NOISE	NOISE	NOISE
COIN (WITH CREDIT)		NOISE	NOISE	NOISE	NOISE
PLAYER-UP		NOISE	NOISE	NOISE	CHIME
SCORE (10,100,1K)		CHIME	CHIME	NOISE	CHIME
SCORE (20K)		CHIME	NOISE	NOISE	CHIME
REPLAY CREDIT		KNOCKER	KNOCKER	KNOCKER	KNOCKER
TILT		NOISE	NOISE	NOISE	NOISE
OUTHOLE		CHIME	CHIME	CHIME	CHIME
GAME OVER		NOISE	NOISE	NOISE	NOISE

### GAME FEATURE OPTIONS:

Saucer & flipper feeder lane adjustment:

Liberal	SW. 8 ON	Saucer 5,000 and flipper feeder lanes on at start of game.
Conservative	SW. 8 OFF	Saucer 5,000 on after making PARTON. Left flipper feeder lane on after making DOLLY PARTON.

Drop targets spotting Parton adjustment:

Liberal	SW. 14 ON	Hitting drop target spots lit saucer letter.
Conservative	SW. 14 OFF	Hitting drop target does not spot letter

Left and right outlane special recall adjustment:

Liberal	SW. 15 ON	A lit left or right outlane Special not made will be recalled for next ball.
Conservative	SW. 15 OFF	A lit left or right outlane Special not made will not be recalled.

Left and right outlane special lite adjustment:

Liberal	SW. 16 ON	Making DOLLY PARTON lites both specials.
Conservative	SW. 16 OFF	Making DOLLY PARTON lites left special.

2X, 3X, 5X, Bonus multiplier recall adjustment:

Liberal	SW. 23 ON	2X, 3X, or 5X lit bonus will be recalled for next ball.
Conservative	SW. 23 OFF	2X, 3X, or 5X lit bonus will not be recalled for next ball.

Drop target extra ball and special adjustment:

Liberal	SW. 24 ON	Hitting 4 drop targets lites extra ball and special.
Conservative	SW. 24 OFF	Hitting 4 drop targets lites extra ball only.

22,000, 44,000 right and left outlane special adjustment:

Liberal	SW. 32 ON	Making 22,000 lites left special.
Conservative	SW. 32 OFF	Making 44,000 lites right special.

## C. FRONT DOOR GAME ADJUSTMENTS

### High Score Feature Adjustments:

The game is designed to award an extra ball (option) or a free game at each of three score levels. The recommended levels are on the score card in the game.

Any level from 10,000 to 990,000 can be set, as desired. It is also possible to reset or turn off (00) any or all of the levels, if desired.

1. Push and release Self-Test button (See Figure III) at one second intervals approximately six times or until identification number 01 appears on the 'Match/Ball in Play' display.
2. The number on the Player Score Displays is the score level.\* It can be increased, if desired, by holding the credit button in. To decrease the score level, hold the credit button in and depress and release the Self-Test button. Release the credit button when the desired number appears. Note that the level changes 10,000 points at a time. If the number '00' is left on the displays, the high score feature is eliminated for that level.
3. Repeat steps 1 and 2 for the second and third score levels. The identification numbers '02' and '03' on the Match/Ball in Play display are for the second and third levels, respectively.

### High Score to Date and 1,000,000 Feature:

The game is designed to award free games when 'High Score to Date' is beat, or if the player exceeds 1,000,000 points.

It is recommended that the level, which will build with play, be periodically reset to the factory recommended level to encourage game play. The adjustment procedure is the same as for the High Score Feature Adjustment, Steps 1 and 2. Continue pushing the Self-Test button until the identification number '04' appears on the 'Match/Ball in Play' display and then do Step 2.

Any level from '00' to 990,000 can be set as described. It is to be noted that '00' does NOT turn off the feature, as it does on High Score feature. The feature is turned off by positioning switches as discussed under 'Back Box Game Adjustments.'

\*Can be quickly set to '00' by pressing S33 on the MPU assembly in the back box or Coin Chute switch #3. (See Figure III).

## RUBBER PARTS

A. R-521	3/4" Dia.	(3)
B. R-521-4	2 1/2" Dia.	(4)
C. R-521-3	2" Dia.	(4)
D. R-521-2	1 1/2" Dia.	(4)
E. R-406-3	Flippers	(2)
F. R-243	5/16" Dia.	(5)

## PANEL TOP PARTS

1. Arch Rail	M-1774
2. Rail Post	C-907 (2)
3. Rail Post	C-988 (2)
4. Bottom Arch	P-5871-69
5. Shooter Gauge	P-6359-35
6. Ball Rebound	ASE-493-6
7. Ball Gate	A-1475-13
8. Screened Plastics	M-1330-160
9. Target Assy. (Red)	ASE-2911-3 (5)
10. Ball Guide Wire	M-121-58
11. Thumper Cap	A-3713-54
12. Thumper Cap	A-3713-55
13. Thumper Cap	A-3713-56
14. In Line Target Assy.	ASE-2993-2
15. Spinner Gate Assy.	ASE-2250-72
16. Ball Gate & Wire Assy.	ASE-2250-24
17. Target Assy. (Red)	ASE-2911-31
18. Guide Rail Assy.	A-3032-37
19. Ball Guide Wire	M-121-18 (3)
20. Target Assy. (White)	ASE-2911-20
21. Rollover Wire & Brkt.	ASE-2806 (5)
22. Ball Guide Wire	M-121-43
23. Ball Guide Wire	M-121-44
24. Buffer Wires	M-121-53 (2)
25. Flipper & Shaft Assy.	ASE-2214-24 (2)
26. Outhole Wire & Brkt.	ASE-2806-21
27. Shooter Lane Hood	P-1732
28. Ball Guide Wire	M-121-34 (2)
29. Minnipost Assy (3)	ASE-8836-1

CONS. — Conservative  
 MED. — Medium  
 LIB. — Liberal

Indicates moveable posts for scoring adjustments.

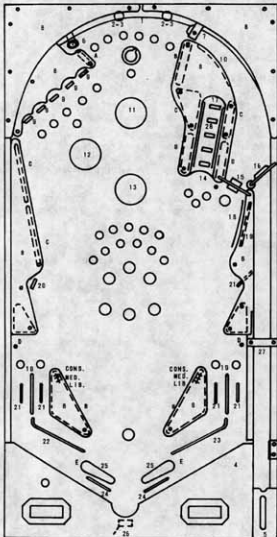

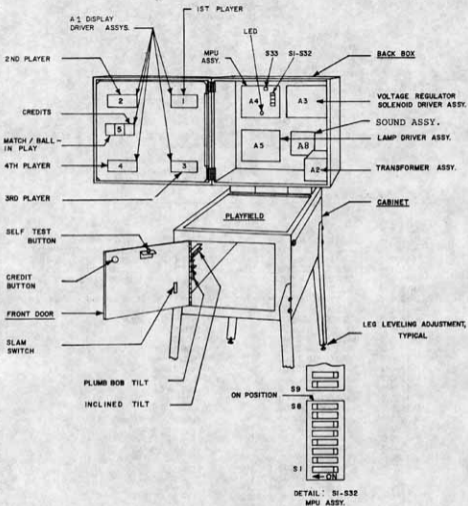

FIGURE III. ELECTRONIC PIN BALL MACHINE

## RECOMMENDED

Instruction, Score Cards and High Score Feature settings  
to be used on **DOLLY PARTON #1162-E**.

### 3-BALL

### 5-BALL

#### REPLAYS

Instruction Card M-1508-85-E  
Score Card M-1508-85-B  
1 Replay at 260,000  
1 Replay at 500,000

#### REPLAYS

Instruction Card M-1508-85-TT  
Score Card M-1508-85-A  
1 Replay at 320,000  
1 Replay at 560,000

#### EXTRA BALL

Instruction Card M-1508-85-F  
Score Card M-1508-85-MM  
1 Extra Ball at 240,000  
1 Extra Ball at 480,000  
1 Extra Ball at 700,000

#### EXTRA BALL

Instruction Card M-1508-85-F  
Score Card M-1508-85-NN  
1 Extra Ball at 270,000  
1 Extra Ball at 510,000  
1 Extra Ball at 730,000

(all playfield posts in medium position)

### ADDITIONAL CARDS

#### REPLAYS

M-1508-H	120,000	360,000	
M-1508-I	140,000	380,000	
M-1508-J	160,000	400,000	
M-1508-K	180,000	420,000	
M-1508-L	200,000	440,000	
M-1508-M	220,000	460,000	
M-1508-N	240,000	480,000	
M-1508-O	260,000	500,000	
M-1508-P	280,000	520,000	
M-1508-Q	300,000	540,000	
M-1508-R	320,000	560,000	
M-1508-S	340,000	580,000	
M-1508-T	360,000	600,000	
M-1508-U	380,000	620,000	
M-1508-V	400,000	640,000	
M-1508-W	420,000	660,000	
M-1508-X	440,000	680,000	
M-1508-Y	460,000	700,000	
M-1508-AA	140,000	430,000	580,000
M-1508-BB	160,000	450,000	600,000
M-1508-CC	180,000	470,000	620,000
M-1508-DD	200,000	490,000	640,000
M-1508-EE	220,000	510,000	660,000
M-1508-FF	240,000	530,000	680,000
M-1508-GG	260,000	550,000	700,000
M-1508-HH	280,000	570,000	720,000
M-1508-II	300,000	590,000	740,000
M-1508-JJ	320,000	610,000	760,000
M-1508-KK	340,000	630,000	780,000
M-1508-LL	360,000	650,000	800,000

#### EXTRA BALL

M-1508-MM	240,000	480,000	700,000
M-1508-NN	270,000	510,000	730,000
M-1508-OO	300,000	540,000	760,000
M-1508-PP	330,000	570,000	790,000
M-1508-QQ	360,000	600,000	820,000
M-1508-RR	390,000	630,000	850,000
M-1508-SS	420,000	660,000	880,000

#### Instruction Card, Novelty

M-1508-85-G  
M-1508-85-UU  
M-1508-85-VV  
M-1508-85-WW  
M-1508-85-XX  
M-1508-85-YY  
M-1508-85-ZZ

#### BLANKS (3)

High game to date recommended levels;  
(reset periodically)  
3 BALL 580,000  
5 BALL 640,000

## #1162-E DOLLY PARTON RECOMMENDED SETTINGS

### SPECIAL: REPLAY

		3 BALL	5 BALL
	SW 6	ON	ON
	SW 7	ON	ON
Saucer and flipper feeder lane	SW 8	ON	OFF
Drop targets spotting PARTON	SW 14	ON	ON
Left & right outlane special recall	SW 15	OFF	OFF
Left & right outlane special lite	SW 16	OFF	OFF
2X, 3X, 5X bonus recall	SW 23	ON	OFF
Drop target extra ball & special	SW 24	ON	OFF
22,000, 44,000 right & left outlane spec.	SW 32	ON	OFF

The following chart gives recommendations for 3 typical types of operation.

	3 BALL	5 BALL
<b>REPLAY</b>		
Instruction Card	M-1508-85-E	M-1508-85-TT
Score Card	M-1508-85-B	M-1508-85-A
Major Mode	SW 6, 7, ON	SW 6, 7, ON
Match	SW 28 ON	SW 28 ON
High Score to Date	SW 21, 22, ON	SW 21, 22, ON
<b>X-BALL</b>		
Instruction Card	M-1508-85-F	M-1508-85-F
Score Card	M-1508-85-B w/mm	M-1508-85-A w/nm
Major Mode	SW 6 OFF	SW 6 OFF
	SW 7 ON	SW 7 ON
Match	SW 28 OFF	SW 28 OFF
High Score to Date	SW 21, 22 OFF	SW 21, 22 OFF
<b>NOVELTY</b>		
Instruction Card	M-1508-85-G	M-1508-85-G
Major Mode	SW 6, 7 OFF	SW 6, 7 OFF
Match	SW 28 OFF	SW 28 OFF
High Score to Date	SW 21, 22 OFF	SW 21, 22 OFF



## VIII. ROUTINE MAINTENANCE ON LOCATION:

Self-Test routines are written into the game design. They are particularly useful for routine maintenance. The tests are described below. The first test is automatic and occurs on power-up. This test causes the MPU module A4 to examine itself for failures. Seven flashes of an LED indicates proper operation. The second series of self-diagnostic tests causes the MPU to 'exercise' each of the other modules in such a way as to make their faults, if any, obvious. See Figure III and Page ii.

It is recommended that these tests be used several times a week to check out the games before play. If faults are discovered, they may be corrected on location if the operator has a stock of replacement modules. See "Trouble Shooting on Location."

### MPU Module Self-Test:

At power on, the LED on the MPU module flashes once. (Flicker-Flash). After a pause, it flashes six more times and goes out. A power-up tune is played to announce game readiness. This indicates proper MPU operating condition and successful completion of the power-up test.

### Game Self-Diagnostic Tests:

1. Pressing the Self-Test button inside the door initiates the Self-Test routine. See Figures III and IV. All switched lamps flash off and on continuously.
2. Pressing the Self-Test button again causes each digit on each display to cycle from 0 thru 9, and repeat continuously.
3. Pressing the Self-Test button again causes each solenoid to be energized, one at a time, in a continuous sequence. Hold both flipper buttons 'in' during this test. The number appearing on the Player Score displays is the same as the number assigned to the solenoid. The sound of a solenoid pulling-in as a number appears indicates proper operation. The absence of sound is improper. If sound is absent, see Page 17 for help in Solenoid identification.
4. Pressing Self-Test button again causes the sound module to play the "Game Over" tune repeatedly.
5. Pressing the Self-Test button again causes the MPU to search each switch assembly for stuck contacts. If any are found, the number of the first set encountered is flashed on the Player Score displays. The number remains until the fault is cleared. See Page 17 for help in Stuck Switch Identification. Other numbers may follow if more stuck contacts are present. If there are no stuck switches, the Match/Ball in Play display flashes '0'.
6. Pressing the Self-Test button 14 more times causes the MPU to step thru the threshold and bookkeeping functions described previously and finally to repeat the power-up test. For more rapid exit to power-up, turn the game off, then on. The game is now ready to play.

After successful completion of the Self Diagnostic Test procedure, set the game up for play. Exercise each rollover, thumper-bumper, slingshot, etc., by hand until each switch assembly on the playfield has been checked for proper operation. If actuating a switch assembly results in intermittent or no response, clean contacts by gently closing them on a clean business card or piece of paper and wiping until they wipe clean. Regap, if necessary, to 1/16". Do not burnish or file Gold Plated Switch Contacts.

## IX. TROUBLESHOOTING ON LOCATION

The game is designed to make troubleshooting easy. Several simple procedures are given herein that cover the greatest percentage of game failures. They are written for an operator on location and require module replacement. (See Figure III) Symptoms and the action to be taken, are given for each type of problem.

If the problem is more complicated and is not solved by following this procedure, more detailed procedures are available from Bally. See the Parts List for ordering information.

## FIGURE IV SELF DIAGNOSTIC TEST

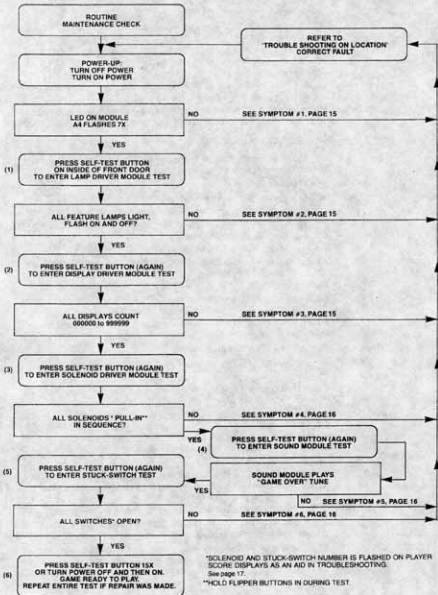

- 1A) SYMPTOM:** Game does not play power-up tune when power is turned on. General illumination is present.
- ACTION:**
- A)** Turn power OFF. Open back box. Locate light emitting diode (LED) on MPU module A4.
  - B)** Turn Power ON. LED must flash 7X to indicate that module A4 is good. Correct flash sequence is flicker/flash-pause-and then six more flashes and LED goes out.
  - C.** If LED does not come on, or does not flash, or flashes, but less than 7X, turn off power. Replace MPU module A4.
- CAUTION:** **Replacement MPU Module must have same Part Number or incorrect operation will result! See Parts List for MPU Module Part Number.**
- Turn power ON.
- D)** If game is correct, it is now ready for play. If game is not correct, refer to Module Replacement procedure. (See Parts List.)
- 2A) SYMPTOM:** Not all feature lamps light during game play.
- ACTION:**
- A)** With power ON, open front door. Press button (Self-Test switch) once. If the game is correct, all feature lamps flash ON and OFF.
  - B)** Carefully raise playfield or open back box to gain access to lamps.
  - C)** Replace bulbs that do not flash.
  - D)** If game is correct, it is now ready for play.
  - E)** If game is not correct, turn power OFF. Replace Lamp Driver Module A5. Turn power ON and repeat A.
  - F)** If game is correct, it is now ready for play.\*
  - G)** If game is not correct, turn power OFF. Replace MPU module A4. See CAUTION, 1C. Turn power ON and repeat A.
  - H)** If game is correct, it is now ready for play.\* If game is not correct, refer to Module Replacement procedure. (See Parts List.)
- 2B) SYMPTOM:** One or some switched lamps always ON.
- ACTION:** Repeat 2AA, AB, AE, and AF and, if necessary AG & AH.
- 3A) SYMPTOM:** Display digits improper on **one** or **several**, but less than all Display Driver module(s), A1. Improper: One or several segments always OFF, digits mottled or several segments or digit(s) always ON.
- ACTION:**
- A)** With power ON, open front door. Press button (Self-Test switch) twice. If the game is correct, each digit on each Display Driver Module A1 (5 used/game) displays the count 1-9 and 0 continuously in all 6 digit positions. Note defective Display Driver modules.
  - B)** Turn power OFF.
- CAUTION: High Voltage is supplied to the Display Driver Modules, A1, from the Solenoid Driver/Voltage Regulator Module A3. Wait 30 seconds for High Voltage to Bleed Off.**
- C)** Replace Display Driver module(s) A1. Turn power ON. Repeat A.
  - D)** If game is correct, it is now ready to play.\* If game is not correct, refer to Module Replacement procedure. (See Parts List.)
- 3B) SYMPTOM:** All displays improper (all five display Driver modules). Improper: Digit(s) always on or off/segment(s) always on or off, all displays.
- ACTION:**
- A)** Repeat 3AA, and AB.
  - B)** Replace MPU module A4. See CAUTION NOTE, 1C. Turn power ON. Repeat A.

- C) If game is correct, it is now ready to play\* If game is not correct, refer to Module Replacement procedure. (See Parts List.)
- 3C) **SYMPTOM:** One or several displays always off.  
**ACTION:** A) Do 3AA, AB, AC, and AD.  
 B) Repeat 3BB and BC, if necessary.
- 4A) **SYMPTOM:** Solenoid(s) do(es) not pull-in during course of game.  
**ACTION:** A) With power ON, open front door. Press button (Self-Test switch) three times.  
 B) If game was correct, each solenoid would be energized. A number is flashed on the Player Score displays as each solenoid is pulsed. Note any numbers that do not have the sound of a solenoid associated. See Solenoid Identification Table, Page 17 and Figure V.  
 C) Carefully lift the playfield (or open the back box) to gain access to the solenoid. Turn power OFF. Inspect the solenoid.  
 D) If a lead is broken off, repair. Repeat A & B. If game is correct, it is now ready to play\* If solenoid wiring was correct, turn power OFF.  
 E) Replace Solenoid Driver/Voltage Regulator module A3. See CAUTION NOTE 3AB.  
 F) Repeat AA & AB. If game is correct, it is now ready to play\* If game is not correct, turn power OFF.  
 G) Replace Sound Module A8.  
 H) Repeat AA and AB if game is correct. It is now ready to play. If game is not correct, turn power OFF.  
 I) Replace MPU module A4. See CAUTION NOTE, 1C.  
 J) Repeat A & B. If game is correct, it is now ready to play\* If game is not correct, refer to Module Replacement Procedure. (See Parts List.)
- 4B) **SYMPTOM:** Solenoid(s) always energized—Note: if impulse solenoids (ball ejects, slingshots, thumper-bumpers, etc.) are energized continuously, they are subject to damage. Limit troubleshooting to one minute with power ON, followed by **five minutes with power OFF**. Repeat as necessary. Replace damaged solenoids.  
**ACTION:** Do 4AA, AB, AE, AF, AG, AH and if necessary, AI and AJ.
- 5) **SYMPTOM:** No Sound.  
**ACTION:** A) With Power ON, open front door, press Self-Test switch four times.  
 B) Turn volume control clockwise to Max.  
 C) If correct, sound will be heard. If incorrect, try seating speaker lead connector (J2) and input connector (J1).  
 D) If correct, sound will be heard. If incorrect, refer to Module Replacement procedure.\*
- 6) **SYMPTOM:** Feature (Drop Targets, etc.) does not score.  
**ACTION:** A) With power ON, open front door. Press button (Self-Test switch) five times.  
 B) If the game is correct, Match/Ball in Play display would flash '0'. If a number appears on the Player Score displays, see Switch Assembly Identification Table, Page 17 and Figure V.  
 C) Carefully lift the playfield. Locate the switch assembly identified from the number. Visually inspect the switch assembly. If the contacts are 'stuck', regap them to 1/16". See section under ADJUSTMENTS. Repeat A & B. If the game is correct, it is now ready to play\* If game is not correct, turn the power OFF.  
 D) Replace MPU module A4. See CAUTION NOTE 1, C.  
 E) Repeat A & B. If the game is correct, it is now ready to play\* If the game is not correct, refer to Module Replacement Procedure. (See Parts List.)
- 7) **SYMPTOM:** Game blows fuse(s) repeatedly.  
**ACTION:** See Module Replacement Procedure. F.O. 560

\*Turn power On-Off switch OFF and then ON.

**GAME # 1162 DOLLY PARTON (figure V)**

**SOLENOID IDENTIFICATION TABLE**

<b>Self-Test #</b>	<b>SOLENOID IDENTIFICATION</b>	<b>Self-Test #</b>	<b>SOLENOID IDENTIFICATION</b>
01	OUTHOLE KICKER	08	LEFT SLINGSHOT
02	KNOCKER	09	DROP TARGET RESET
03	LEFT THUMPER BUMPER	10	COIN LOCKOUT DOOR
04	BOTTOM THUMPER BUMPER	11	K1 RELAY (flipper enable)
05	TOP THUMPER BUMPER		
06	PARTON SAUCER		
07	RIGHT SLINGSHOT		

**SWITCH ASSEMBLY SELF-TEST DISPLAY NUMBERS**

<b>Self-Test #</b>	<b>SWITCH DESCRIPTION</b>	<b>Self-Test #</b>	<b>SWITCH DESCRIPTION</b>
01	DROP TARGET 5X	21	FLIP/FEED LANE (RT)
02	DROP TARGET 3X	22	FLIP/FEED LANE (LF)
03	DROP TARGET 2X	23	LEFT OUTLANE
04	FIRST DROP TARGET	24	PARTON SAUCER
05	SUPERSTAR TARGET	25	
06	CREDIT BUTTON	26	
07	TILT (3)	27	
08	OUTHOLE	28	"Y" TARGET
09	COIN III (RIGHT)	29	2nd "L"
10	COIN I (LEFT)	30	1st "L"
11	COIN II (MIDDLE)	31	"O" TARGET
12		32	"D" TARGET
13		33	
14		34	30 PT REBOUND (5)
15		35	5,000 SIDE ROLLOVER
16	SLAM (2)	36	RIGHT SLINGSHOT
17	SPINNER	37	LEFT SLINGSHOT
18		38	TOP THUMPER BUMPER
19	WHITE 500 POINT TARGET	39	BOTTOM THUMPER BUMPER
20	RIGHT OUTLANE	40	LEFT THUMPER BUMPER

**NOTE: SLINGSHOT & THUMPER BUMPER COILS  
WILL BE ENERGIZED WHEN SWITCH IS MADE.**

#1162 DOLLY PARTON

○ INDICATES SWITCH ASSEMBLY  
IDENTIFICATION NUMBERS.

NOTE: CABINET: 07, 16  
DOOR: 06, 09,  
10, 11, 16

□ INDICATES SOLENOID  
IDENTIFICATION NUMBERS.

NOTE: DOOR: 10  
BACKBOX: 11  
CABINET: 02

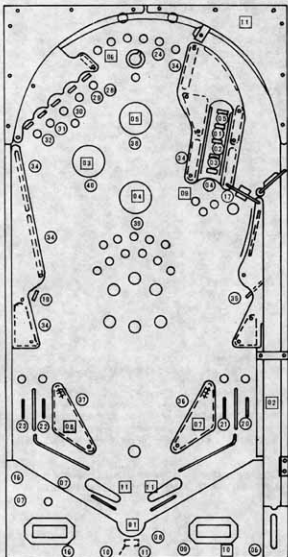

FIGURE V

## ASSEMBLY ADJUSTMENTS:

### GENERAL:

All switch assemblies consist of leaf springs, contacts, separators, plastic tubing and screws to hold them to the mounting surface. Before attempting to adjust a switch assembly, make sure that these screws are tight. If not, tighten screw closest to the contact end of the leaf spring first. This will prevent the assembly from being secured in such a manner that the leaf springs tend to fan out. In general, all leaf springs are adjusted for a 1/16" gap in the open position and .010" overtravel or wipe in the closed position. All contacts should be in good condition. Unless otherwise instructed, they should be dry or non-lubricated. All contacts should be free of dust and dirt. Contacts, with the exception of the flipper button switch assemblies, are plated to resist corrosion. Filing or burnishing breaks the finish and encourages corrosion. Clean by closing the contacts over a clean piece of paper (e.g. a business card) and wiping gently until the contacts are clean. For the flipper button switch assemblies **ONLY**: Tarnish can be removed with a contact file followed by a burnishing tool. Severely pitted contacts must be replaced as an assembly. In general, contacts need be cleaned or replaced and adjusted only when they are found to be a source of game malfunction.

## X. SERVICE PARTS:

A parts catalogue is available upon request. The catalogue is illustrated and lists all replacement parts for each game manufactured by Bally. Requests should be addressed to:

BALLY MANUFACTURING CORPORATION  
2640 WEST BELMONT AVENUE  
CHICAGO, ILLINOIS 60618  
ATTN: PARTS DEPARTMENT

### SERVICE HINTS:

The Bally playfield has an improved tuff-coat finish with excellent wearing properties. Its life expectancy, as well as play appeal, can be extended by periodic cleaning of the playfield.

**DO:** Bally recommends you clean your playfield with Wildcat #125 (Wildcat Chemical Co., 1333 W. Seminary Drive, Ft. Worth, Texas 76115). Wildcat #125 is a combination cleaner and polish. Bally has tried and tested this product and found it to be very effective. If Wildcat #125 is not available, Bally suggests you ask your Distributor to order it. Inspect and hand polish the ball in a clean cloth. A chipped ball must be replaced. It can ruin the finish on the playfield in a short period of time.

**DON'T:** Use water in large quantities, highly caustic cleaners, abrasive cleaners or cleaning pads on the playfield. Do not allow a wax or polish build up. Waxes yellow with age and spoil play appeal.

**XI. PARTS LIST**  
**#1162-E DOLLY PARTON**

<b>MISCELLANEOUS</b>	<b>PART NUMBER</b>
Transformer (Domestic or Export) .....	E-122-125
Bulbs, #44 .....	E-125-22
Fuse, 1 Amp. 3 A6 Slow Blow (Playfield Solenoid Protection) .....	E-133-44

<b>ASSEMBLY COILS</b>	
Coin Lockout .....	FO-36-7000
Flipper (2) .....	AQ-25-500/ 34-4500
Knocker .....	AR-26-1200
Outhole Kicker .....	AN-26-1200
Thumper-Bumper (3) .....	AN-26-1200
Sling-Shot (2) .....	AN-26-1200
Drop Target Reset .....	NO-26-1900
Saucer (1) .....	AO-27-1300

**PLAYFIELD PARTS** See Figure II

<b>MODULES</b>	
Lamp Driver A5 .....	AS-2518-23
Display Driver A1 (5 used) .....	AS-2518-21
Solenoid Driver/Voltage Regulator A3 .....	AS-2518-22
MPU A4 .....	AS-2962-12
Transformer & Rectifier A2 .....	AS-2877-1
Rectifier Board (Part of A2) .....	AS-2518-18
Sound .....	AS-2888-4

<b>REPAIRS PROCEDURES/AIDS</b>	
Module & Component Replacement .....	FO.560-1
AID (Assistance in Diagnostics)	
Kit, used with F.O.560-1 .....	KIT #485-1

**MODULE COMPONENTS**  
 SEE MODULE PARTS LIST

**MODULE COMPONENT STARTER KITS**  
 (Each Kit contains an assortment of the most needed electronic parts for use in Module repair.)  
 Kit #490—For Rectifier Board (Part of A2)  
 Kit #503—For MPU Board A4 (Less Memory U1-U6)  
 Kit #492—For Solenoid Driver/Voltage Regulator A3  
 Kit #493—For Display Driver A1  
 Kit #494—For Lamp Driver A5  
 Kit #518—For Sound A8



# AS-2518-35 MPU MODULE

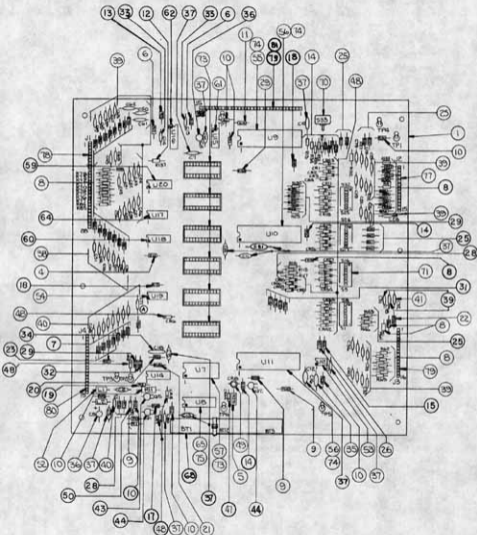

### A4: MPU MODULE COMPONENT PARTS LIST

ITEM	REFERENCE DESIGNATION	BALLY PART #	DESCRIPTION
1	A4 (see note 1)	AS-2962-12	MPU Module Complete, Dolly Parton
2	A4 (see note 2)	AS-2518-35	MPU Module less Program Memory, U1-6 Incl.
3-32	See Schematic		Resistors, See schematic for value
33	C14, C15	E-00586-0067	Capacitor, 470 PFD, 1kv
34	C18	E-00586-0088	Capacitor, .05 MFD, 16V
35	C16	E-00586-0081	Capacitor, .1 MFD, 100V
36	C4, C5	E-00586-0073	Capacitor, 4.5 MFD, 25V
37	C3, C6-C13, C17, C81	E-00586-0085	Capacitor, .01 MFD, 25V
38	C79, C41-C67	E-00586-0083	Capacitor, 470 PFD, 50V
39	C19-C31, C78, C33-C40	E-00586-0082	Capacitor, 390 PFD, 50V
40	C1, C2, C68-C77	E-00586-0084	Capacitor, 820 PFD, 50V
41	C32	E-00586-0077	Capacitor, 3000 PF, 1kv
43	Q5	E-00585-0023	Transistor PNP (MPS-3702)
44	Q1, Q2	E-00585-0031	Transistor (2N3904)
47	CR44	E-00587-0006	Diode (1N4004)
48	CR1-CR7, CR11-CR43, CR45-CR49	E-00587-0014	Diode (1N4148)
49	CR8	E-00679	LED (Green)
50	VR1	E-00598-0008	Diode Zener (8.2V, 1N9598)
52	L1, L2	E-00604-0003	Inductor, 22 Micro Hy.
53	U12	E-00620-0004	Timer (555)
54	U19	E-00620-0005	Quad 2 Input (4011)
55	U9	E-00620-0028	MPU I.C. (6800)
56	U10, U11	E-00620-0029	PIA I.C. (6820)
57	U7	E-00620-0030	RAM I.C. (6810)
59	U20	E-00620-0032	HEX Buffer I.C. (14502B)
60	U14, U18	E-00620-0033	HEX Inverter (4049B)
61	U15	E-00620-0034	Quad Memory Drive (MC3459L)
62	U16	E-00620-0035	Dual Monostable (9602)
64	U17	E-00620-0041	Quad 2 Inputs (74L00N)
65	U8	E-00620-0042	RAM (C MOS, P5101L-3)
68	BT1, BT2, BT3	E-00628-0003	Battery
70	S33	E-00658-0001	Push Button Switch
71	S1-S8, S9-S16, S17-S24, S25-S32	E-00677	DIP Switch
73		E-00712	24 Pin Socket
74		E-00712-0001	40 Pin Socket
75		E-00712-0003	22 Pin Socket
77	J2	E-00715	15 Pin Wafer Connector
78	J1	E-00715-0004	28 Pin Wafer Connector
79	J3, J5	E-00715-0017	16 Pin Wafer Connector
80	J4	E-00715-0018	19 Pin Wafer Connector
81	J5	E-00715-0024	17 Pin Wafer Connector

#### NOTE 1:

When ordering, fill in dash number. For example, AS-2962-0: LOST WORLD, AS-2962-2: SIX MILLION DOLLAR MAN, AS-2962-3: PLAYBOY, AS-2962-4: VOLTAN, AS-2962-5: SUPERSONIC, AS-2962-6: STAR TREK, AS-2962-7: KISS, AS-2962-8: PARAGON, AS-2962-9: GROUND SHAKER, AS-2962-10: HARLEM GLOBE-TROTTERS, AS-2962-12: DOLLY PARTON.

#### NOTE 2:

Order replacement memory chips U1-U6, specifying game, socket and part number stamped on chip.

## AS-2518-23 LAMP DRIVER MODULE

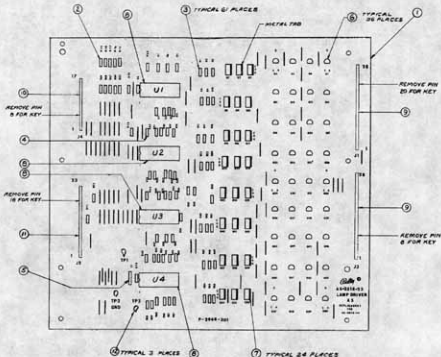

### A5: LAMP DRIVER MODULE COMPONENT PARTS LIST

ITEM	REFERENCE DESIGNATION	BALLY PART #	DESCRIPTION
1	A5	AS-2518-23	Lamp Driver Module, Complete
2	R71-R79	E-00105-242	Resistor, 20k $\Omega$ , 5%, 1/4 W
3	R1-R60, R70	E-00105-0237	Resistor, 2k $\Omega$ , 5%, 1/4 W
4	R61-R69	E-00105-0256	Resistor, 2.2M $\Omega$ , 1/4 W
5	C1	E-00586-0065	Capacitor, .01 MFD, 500V
6	Q4-Q7, Q11-Q14, Q18-Q21, Q25-Q32, Q36-Q39, Q43-Q46, Q50-Q53, Q57-Q60	E-00585-0014	SCR, 2N5060
7	Q1-Q3, Q8-Q10, Q15-Q17, Q22-Q24, Q33-Q35, Q40-Q42, Q47-Q49, Q54-Q56	E-00585-0029	SCR, MCR106-1
8	U1-U4	E-00620-0037	I.C., Decoder, 14514B
9	J1, J3	E-00715-0004	28 Pin Wafer Connector
10	J4	E-00715-0024	17 Pin Wafer Connector
11	J2	E-00715-0014	23 Pin Wafer Connector
12	TP1, TP2, TP3	P-05399	Test Clip

## AS-2518-21 DISPLAY DRIVER MODULE

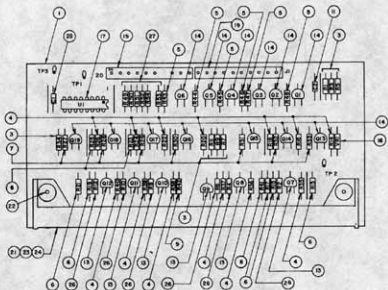

**A1: DISPLAY DRIVER MODULE  
COMPONENT PARTS LIST**

ITEM	QTY.	REFERENCE DESIGNATION	BALLY PART #	DESCRIPTION
1	1		P-2948-298	P.C. Board, M-645-392
3	7	R1, R3, R5, R7, R9, R11, R34	E-105-226	Resistor, 100K $\Omega$
4	13	R14, R16, R18, R20, R22, R24, R26, R35, R36, R37, R38, R39, R40	E-105-227	Resistor, 300K $\Omega$
5	6	R43, R44, R45, R46, R47, R48	E-105-228	Resistor, 9.1K $\Omega$
6	7	R13, R15, R17, R19, R21, R23, R25	E-105-229	Resistor, 1.5K $\Omega$
7	7	R27, R28, R29, R30, R31, R32, R33	E-105-230	Resistor, 1K $\Omega$
8	1	R41	E-105-231	Resistor, 39K $\Omega$
9	1	R42	E-105-271	Resistor, 240K $\Omega$
10				
11	1	C2	E-586-85	Capacitor, .01 MFD, 500V
13	6	Q7, Q8, Q9, Q10, Q11, Q12	E-585-32	Transistor (2N5401)
14	13	Q1, Q2, Q3, Q4, Q5, Q6, Q13, Q14, Q15, Q16, Q17, Q18, Q19	E-585-33	Transistor (MPS-A42)
16	1	VR1	E-598-7	Zener Diode, 110V
17	1	U1	E-620-38	I.C. Decoder
18				
19	2	J1	E-715-34	10 Pin Wafer Pin Connector
21	1	DS1	E-680	Digital Display Panel
22	2		M-1836	Hi-Lo Screw, W/H
23	1		P-2399	Display Mounting (Top)
24	1		P-2399-1	Display Mounting (Bottom)
26	6	R2, R4, R6, R8, R10, R12	E-105-287	Resistor, 2.2K $\Omega$
27	6	R49, R50, R51, R52, R53, R54	E-105-242	Resistor, 20K $\Omega$
28	As Req'd			Wire Jumper
29	1	C1	E-586-85	Capacitor, .01 MFD, 25V

NOTE: INTERCHANGEABLE WITH AS-2518-15

# AS-2518-22 SOLENOID DRIVER/VOLTAGE REGULATOR MODULE

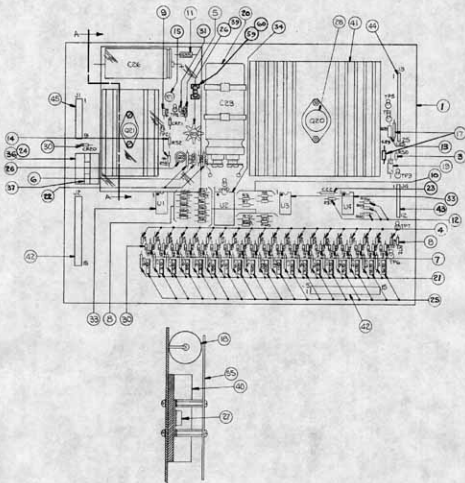

NOTE: INTERCHANGEABLE WITH AS-2518-16

**A3: SOLENOID DRIVER/VOLTAGE REGULATOR MODULE****COMPONENT PARTS LIST**

ITEM	REFERENCE DESIGNATION	BALLY PART #	DESCRIPTION
1	A3	AS-2518-22	Solenoid Driver/Voltage Regulator Module, Complete
3-14	Resistors		Resistor, See Schematic for value.
15	RT1	E-00599-0014	Pot. (Linear) 25K
17	C25, 29	E-00586-0014	Capacitor, .1 MFD, 20V
18	C26	E-00586-0059	Capacitor, 160 MFD, 350V
19	C24	E-00586-0063	Capacitor, 2 MFD @ 25V
20	C23	E-00586-0062	Capacitor, 11700 MFD, 20V
21	C1-C8, C11-C21	E-00586-0064	Capacitor, .002 MFD, 1kv
22	C27, C28	E-00586-0065	Capacitor, .01 MFD, 500V
24	K1	E-00146-0795	Relay, Printed Circuit
25	Q1-Q19	E-00585-0034	Transistor, SE9302
26	Q22, Q23	E-00585-0041	Transistor, 2N3440
27	Q21	E-00585-0042	Transistor, 2N3584
28	Q20	E-00710	+5V Regulator, LAS1405 or 78H05KC or LM323K
30	CR1-CR21	E-00587-0015	Diode (1N4004)
31	VR1	E-00598-0010	Diode, Zener 140V, IN5275A
33	U1, U3, U4	E-00681	I.C. Transistor Array, CA3081
34	U2	E-00620-0039	I.C. Binary to 1/16 Decoder, 74L154
36		E-00592-0002*	Relay Socket
37		M-1839*	Relay Holder
39		E-00682	Heat Sink, TO5
40		E-00682-0001	Heat Sink, TO66
41		E-00682-0002	Heat Sink, TO3 Case
42		E-00715-0039	15 Pin Wafer Connector
43		E-00715-0016	12 Pin Wafer Connector
44		E-00715-0020	25 Pin Wafer Connector
45		E-00715-0033	9 Pin Wafer Connector
55		M-1838	Shield-Plexiglass
59		E-00148-0021	Fuse Clips
60	F1	E-00133-0029	Fuse 8 AG-3/16 Amp.
23	C22	E-00586-0085	Capacitor, .01 MFD, 25V

\*USED WITH ITEM 24, E-00146-0791, PLUG IN RELAY ONLY

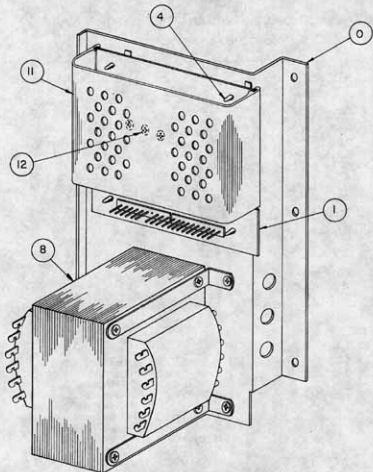

**A2: POWER TRANSFORMER MODULE  
COMPONENT PARTS LIST**

ITEM	REFERENCE DESIGNATION	BALLY PART #	DESCRIPTION
0	A2	AS-2877-1	Power Transformer Module, Complete
1		AS-2518-18	Rectifier Board Assembly
4		M-1829-2a	Circuit Board Support (4 Req'd.)
8		E-00122-0125c	Transformer 120/240V, 50/60 Hz
11		P-2692b	P.C.B Cover
12		M-1834	Heat Sink Compound

# AS-2518-18 RECTIFIER BOARD ASSEMBLY

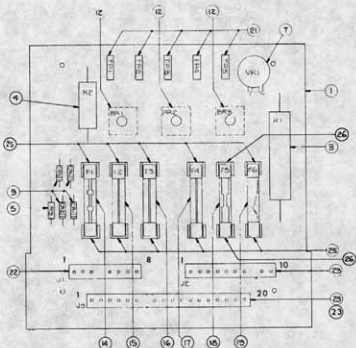

**RECTIFIER BOARD ASSEMBLY**  
(Part of)  
**A2: POWER TRANSFORMER MODULE**  
**COMPONENT PARTS LIST**

ITEM	REFERENCE DESIGNATION	BALLY PART #	DESCRIPTION
1	P/O A2	AS-2518-18	Rectifier Board Assembly, Complete
3	R1	E-00104-0092	Resistor, 10%, 600 Ohm, 10W
4	R2	E-00104-0091	Resistor, 25 Ohm, 5W
5	R3	E-00105-0226	Resistor, 5%, 100K Ohm, 1/4W
7	VR1	E-00623	Varistor
9	CR1, CR2, CR3, CR4	E-00587-0006	Diode (IN4004)
12	BR1, BR2, BR3	E-00602-0003	Bridge Rectifier (VJ248 VARO)
14	F1	E-00133-0010	Fuse, 10A, 32V, 3AG
15	F2	E-00133-0028	Fuse, 3/4A, 250V, 3AG,
16	F3	E-00133-0004	Fuse, 4A, 32V, 3AG
17	F4	E-00133-0005	Fuse, 5A, 32V, 3AG
18	F5	E-00133-0027	Fuse, 20A, 32V, 3AG
19	F6	E-00133-0024	Fuse, 3A, 3AG, S.B.
21		E-00684	Test Point
22	J1, J2, J3	E-00715-0032	8 Pin Wafer Connector
23		E-00715-0034	10 Pin Wafer Connector
25		E-00148-0021	Fuse Clips
26		E-00148-0022	Fuse Clips



## A8: SOUND MODULE COMPONENT PARTS LIST

ITEM	REFERENCE DESIGNATION	BALLY PART #	DESCRIPTION
1	A8 (see note 1)	AS-2888-4	PWB Module Complete—
2	J1	E-00715-0039	15 Pin Connector
3	J2	E-00715-0026	2 Pin Connector
4	TP1-TP5	P-05399	Test Clip
5	R1, R31	E-00105-0239	Resistor 1/4W 5% 4.7K
6	R2, *R28	E-00105-0281	Resistor 1/4W 5% 15K
7	R3	E-00105-0263	Resistor 1/4W 5% 47K
8	R4	E-00105-0257	Resistor 1/4W 5% 3.9K
9	R5, R6, R9, R17, R19, R20, R23, R25, R26, R27, R30, R37, R38	E-00105-0185	Resistor 1/4W 5% 10K
10	R10	E-00105-0248	Resistor 1/4W 5% 150K
11	R11, R12, R14	E-00105-0285	Resistor 1/4W 5% 1M
12	R13	E-00105-0284	Resistor 1/4W 5% 470K
13	R15	E-00105-0279	Resistor 1/4W 5% 360
14	R16	E-00105-0280	Resistor 1/4W 5% 470
15	R18	E-00105-0278	Resistor 1/4W 5% 2.7
16	R8	E-00105-0287	Resistor 1/4W 5% 2.2K
17	R21	E-00105-0246	Resistor 1/4W 5% 110K
18	R22	E-00105-0286	Resistor 1W 4.7K
19	R24	E-00105-0210	Resistor 1/4W 5% 27K
20	R7	E-00105-0289	Resistor 1/4W 5% 1.1K
21	R35	E-00105-0228	Resistor 1/4W 5% 9.1K
22	R36	E-00104-0096	Resistor 5W, 10% 75Ω
23	RT2, RT3	E-00599-0015	Resist. Var. 91B, 10K
24	C1, C10	E-00586-0068	Cap., Disc. 100PF 1000V
25	C14, C15, C18	E-00586-0085	Cap., .01MFD 25V
26	C7, C3	E-00586-0087	Cap., Disc. .02MFD 500V
27	C19, C2, C5, C9, C16, C21, *C22	E-00586-0088	Cap., Disc. .05MFD 16V
28	C4, C12	E-00586-0089	Cap., Disc. .1MFD 25V
29	C8, C11, C23	E-00586-0090	Cap., Elect. 1MFD 25V
30	C6	E-00586-0063	Cap., Elect. 2MFD 25V
31	C13	E-00586-0091	Cap., Elect. 100MFD 25V
32	C17	E-00586-0092	Cap., Elect. 100MFD 100V
33	Q1 (TIP 29)	E-00585-0043	Transistor NPN
34	Q2, Q3 (2N 3904)	E-00585-0031	Transistor NPN
35	CR1, CR2 (1N 4148)	E-00587-0014	Diode
36	CR3 (1N 4004)	E-00587-0015	Diode
37	CR4 (1N 5245)	E-00598-0016	Diode, Zener
38	U1, U8 (MC 14049B)	E-00620-0033	Hex Inverter (I.C.)
39	U4, U5 (MC 14526B)	E-00620-0044	Programmable 4 Bit Counter
40	U2 (MC 14042B)	E-00620-0045	Quad. Latch
41	U7 (555)	E-00620-0004	Timer I.C.
42	U9 (LM 741)	E-00620-0047	Operational Amp.
43	U10 (LM 380N)	E-00620-0048	Audio Amplifier
44	U11 (86 L93)	E-00620-0046	4 Bit Binary
45	C20	E-00586-0064	Cap., Disc. .002
46	A8 (see note 2)	AS-2518-50	PWB Module Less Program Memory U3
47	For Q1	E-00682-0008	Heatsink

NOTE 1: When ordering specify name of game.

NOTE 2: Order replacement memory chip U3 specifying name of game and part no. stamped on chip.

\*Removed R28, C22 for AS-2888-4.

# AS-2518-50 SOUND MODULE

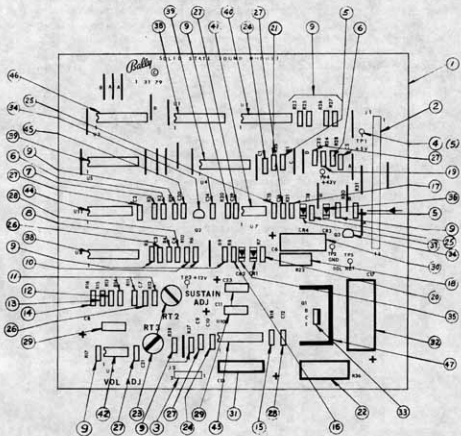

## ATTACHMENT II: INSTRUCTION MANUAL

Female insulation displacement connectors are used in the backbox cable harnesses. These connectors can be identified by the side entry of the leads and by their black, plastic covers.

The mating, white, male connectors on the Sound, Solenoid Driver and Transformer modules have .156" center to center spacing. Two pin lengths are in use. This, and all current games have a .450" length. Older games have a .640" length.

During servicing, when mating insulation displacement connectors on male connectors with a .640" pin length:

1. Hold the female connector parallel to the module surface.
2. Carefully align the openings in the female with the male pins.
3. Mate the connector set firmly but gently while maintaining the parallel relationship.
4. As resistance is encountered, stop applying force. An air gap of about .150" between the male and female connector bodies is normal at complete engagement.

**CAUTION:** It is not necessary or advisable to force the female connector further onto the male pins. Doing so may cause an intermittent connection.

When mating insulation displacement connectors on male connectors with a .450" pin length:

1. Follow steps 1-4 above, but—
2. Disregard the **CAUTION** note. Also, no air gap exists between the connector pair on total engagement.