

**MIDWAY**

August 1994  
16-40036A-101

# CRUIS'N USA

## SINGLE SIT DOWN

**PRELIMINARY MANUAL**

**Operations Manual Includes**

- Operations & Adjustments
- Testing & Problem Diagnosis
  - Parts Information
- Reference Diagrams & Schematics

Midway Manufacturing Company  
3401 North California Avenue  
Chicago, Illinois 60618



# WARNINGS & NOTICES

## Warning

USE OF NON-MIDWAY PARTS OR CIRCUIT MODIFICATIONS MAY CAUSE SERIOUS INJURY OR EQUIPMENT DAMAGE! USE ONLY MIDWAY AUTHORIZED PARTS.

- \* For safety and reliability, substitute parts and modifications are not recommended.
- \* Substitute parts or modifications may void FCC type acceptance.
- \* This game is protected by Federal Copyright, trademark and patent laws. Unauthorized modifications may be illegal under Federal law. This also applies to MIDWAY logos, designs, publications and assemblies. Moreover, facsimiles of MIDWAY equipment (or any feature thereof) may be illegal under federal law, regardless of whether or not such facsimiles are manufactured with MIDWAY components.

## Warning

This equipment generates, uses and can emit radio frequency energy and, if not installed properly and used according to the directions in this manual, may cause interference to radio communications. It has been tested and found to comply with the limits for a Class A computing device pursuant to Subpart J of part 15 of FCC rules which are designed to provide reasonable protection against such interference when operated in a commercial environment. Operation of this equipment in a residential area is likely to cause interference to radio communications, in which the user, at his or her own expense, will be required to take whatever measures may be needed to correct the interference.

## Warning

Prevent shock hazard and assure proper game operation. Only plug this game into a properly grounded outlet. Do not use a cheater plug to defeat the power cord's grounding pin. Do not cut off the ground pin.

## Notice

When MIDWAY ships a game, it is in compliance with FCC regulations. Your sticker is proof. If the sticker is missing or damaged, legal repercussions to the owner or distributor of the game may result. If your game does not contain an FCC sticker, call MIDWAY immediately.

## Notice

No part of this publication may be reproduced by any mechanical, photographic, or electronic process, or in the form of a phonographic recording, nor may be transmitted, or otherwise copied for public or private use, without permission from the publisher.

**For Service: Call your Authorized MIDWAY Distributor.**

**MIDWAY MANUFACTURING COMPANY  
3401 N. CALIFORNIA AVE.  
CHICAGO, ILLINOIS 60618**



## TABLE OF CONTENTS

<b>Section 1 - Operation</b> .....	1-1
<b>Safety Notices</b> .....	1-2
<b>Set-Up Procedure</b> .....	1-3
Location Requirements .....	1-3
Installation & Inspection .....	1-3
<b>Servicing</b> .....	1-5
<b>Game Features</b> .....	1-7
Starting-Up.....	1-7
Player Controls.....	1-7
<b>Game Operation</b> .....	1-8
Cabinet Switches .....	1-8
Control Switches .....	1-8
<b>Menu System Operation</b> .....	1-9
Operation .....	1-9
Main Menu .....	1-9
Diagnostic Tests.....	1-10
Switch Test.....	1-10
DIP Switch Test.....	1-10
CPU Test.....	1-11
Sound Test.....	1-11
Monitor Patterns.....	1-11
Burn-in Test.....	1-11
Game Audits .....	1-12
Game Adjustments.....	1-14
Standard Pricing Table.....	1-16
Custom Pricing.....	1-17
<b>Utilites</b> .....	1-18
<b>Troubleshooting</b> .....	1-19
<b>Notes</b> .....	1-20

<b>Section 2 - Parts Information</b> .....	2-1
Cabinet Hardware.....	2-2
Electronic Rack.....	2-2
Speakers.....	2-2
Transformer Assembly.....	2-2
Dash Assembly.....	2-2
Fluorescent Lamp Assembly.....	2-2
Monitor.....	2-2
Cables.....	2-2
Seat Assembly.....	2-2
Power Supply Switcher Assembly.....	2-3
Wheel Driver Board Assembly.....	2-4
CPU/Sound Board.....	2-6
Dash Assembly.....	2-11
Monitor Cover.....	2-12
<b>Section 3 - Schematics and Diagrams</b> .....	3-1
Notes.....	3-2
JAMMA Chart.....	3-3
Power Wiring Diagram.....	3-4
Cabinet Wiring Diagram.....	3-5

# CRUIS'N USA

SINGLE SIT DOWN





# CRUIS'N USA

SINGLE SIT DOWN

SECTION  
ONE

---

**Operation**

## Safety Notices

The following safety instructions apply to all game operators and service personnel. Specific warnings and cautions will be found throughout this manual where they apply. We recommend that you read this page before preparing your game for play.



**AC POWER CONNECTION.** Before connecting the game to the AC power source, verify that the "line voltage selection chart" jumper wires are installed correctly for the line voltage in your area. For details, refer to Section 3.

**PROPERLY GROUND THE GAME.** To avoid electrical shocks, do not plug in the game until it has been inspected and properly grounded. MIDWAY games should only be plugged into a grounded 3-wire outlet. Shocks will also result, if the control panel is not properly grounded! After servicing any parts on the panel, be sure that the ground wires are secure. Only then should you lock up the game.

**DISCONNECT POWER DURING REPAIRS.** To avoid electrical shock, disconnect the game from the AC power source before removing or repairing any part of the game.

**USE THE PROPER FUSE.** To avoid electrical shock, use the replacement fuse which is specified in the parts list for this game. The replacement fuse must match the original fuse in fuse type, voltage rating, and current rating.

**MONITOR PRECAUTIONS.** When removing or repairing the monitor, extra precautions must be taken to avoid electrical shock. High voltages may exist within the monitor circuitry and cathode ray tube (CRT) even after power has been disconnected. Do not touch internal parts of the monitor with your hands or metal objects! Always discharge the CRT by the following method: Attach one end of a large, well-insulated, 20-kv jumper to ground. Momentarily touch the free end of the grounded jumper to the anode by sliding it under the anode cap. Wait two minutes and discharge the anode again.

**HANDLE FLUORESCENT TUBE AND CRT WITH CARE.** If you drop a fluorescent tube or CRT and it breaks, it will implode! Shattered glass can fly eight feet or more from the implosion.

## ATTENTION!

**PROPERLY ATTACH ALL CONNECTORS.** *Make sure that the connectors on each printed circuit board (PCB) are properly connected. If the connectors do not slip on easily, do not force them. A reversed connector may damage your game and void the warranty. All connectors are keyed to fit specific pins on each board.*

## Set-Up Procedure

### Game Location Requirements

Power: Domestic 115V @ 60 Hz  
Foreign 230V @ 60 Hz

Temp.: 32° F to 100° F  
(0° C to 38° C)

Humidity: Not to exceed 95% relative.

Dimensions (assembled): Width: 30"  
Depth: 61"  
Height: 67"

Weight: Pedestal. 95 Lbs.  
Game 395 Lbs.

### Installation And Inspection

1. Remove all items from shipping containers and set them aside. Inspect the exterior of the cabinet for any signs of damage. Remove shipping cleats from the bottom of the cabinet. Remove pedestal mounting rails packed inside seat liner.
2. Remove keys from the taped coin return slot. Unlock and open the coin and cash box doors. (Leg levelers and spare parts are stored in the cash box).
3. Tilt or lay the cabinet down. Locate two threaded holes on the bottom of the cabinet and install one leg leveler (with its hex nut) in each hole.
4. Stand cabinet upright and make certain it is in a stable position. Level the cabinet.
5. Leg levelers come installed on the pedestal assembly and need only to be leveled before installing onto the cabinet assembly.

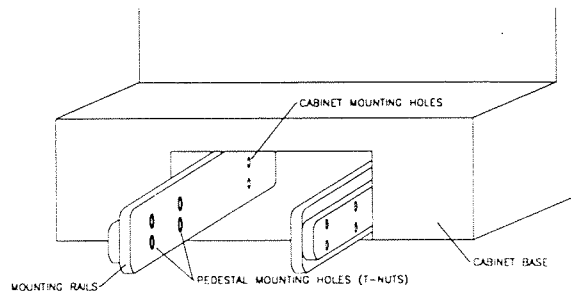

6. Attach mounting rails to cabinet base using four 1/4-20 hex-head bolts (see above diagram for proper placement). Do not tighten bolts completely, some movement is required in the mounting rails to align holes with pedestal assembly.
7. Place pedestal assembly on mounting rails. Align the holes and carefully pull the pedestal away. Hold mounting rails in position and tighten bolts inside cabinet.
8. Connect speaker wire from inside pedestal to cabinet. Attach pedestal assembly and bolt together using eight 1/4-20 tamper proof screws. Use the T27 wrench (20-10140), included in the spare parts, to install these screws.

5. Remove rear door of cabinet. Inspect cabinet interior for any signs of damage. Check all major assemblies to assure that they are mounted securely.
6. Refer to the games Cabinet Wiring Diagram (section 3), and check to see that all cable connectors are correctly secured. **DO NOT FORCE CONNECTIONS.** Watch for damaged connectors and avoid making reversed connections.
8. Determine the value of your line voltage with a meter. Then, check the jumper wire to the main power supply transformer. Be sure it is jumpered to correspond to your local line voltage value. If necessary, change the jumper wire to the transformer in accordance with the Jumper Chart in Section Three.
9. Replace rear cabinet door and screw (lock) it securely. **NOTICE:** Tamper proof screws are included with the spare parts. These screws are optional and may be used to secure the rear door panel. The T20 wrench (20-9620) is used for the installation of these screws. Close and lock the front coin and cash box doors.
10. To attach line cord, the four Phillips-head screws that mount the line cord cover plate to the rear cabinet. Match the prongs on the plug with the holes in the receptacle and push line cord securely into place. Make sure cord aligns with the indentation of plate (indentation should point toward bottom of cabinet). Remount line cord cover plate. If desired, tamper resistant screws are provided to remount cover plate.
11. Connect the line cord to a grounded (3-terminal) AC wall outlet.
12. Switch **ON** the game using the **ON/OFF** switch located on the upper left top of the cabinet, to verify proper operation.

## Servicing

- **Control Panel**

Switch OFF power to the game. Using the T27 wrench, remove four tamper proof screws from the monitor glass retaining bracket, and set bracket aside. Remove four tamper proof screws from under the control panel. Pull control panel out and disconnect the wiring. Before reinstalling the control panel, check for proper wire connections, including ground strap.

- **Remove Viewing Glass**

Switch OFF power to the game. Using the T27 wrench, remove four tamper proof screws holding the monitor glass retaining bracket, and set bracket aside. Carefully raise the glass from its bottom grooved edge and lift it clear of cabinet.

- **Remove Monitor Bezel**

Switch OFF power to the game and remove viewing glass (above). Remove bezel from its grooved edge.

- **Monitor Replacement**

*We recommend that you read the WARNINGS section thoroughly before beginning this procedure.*

Switch OFF power to the game. Remove the viewing glass and the monitor bezel. Completely disconnect the monitor from all of its cabling, including its chassis ground strap.

Remove the six flange nuts securing the monitors mounting flanges to its mounting panel. Pull the monitor carefully from the cabinet front.



**CAUTION** While removing the six flange nuts, firmly support the monitor from the front of the CRT so that it will not slip.



**CAUTION** The monitor DOES NOT contain an isolation transformer in its chassis. It is mounted instead in the Power Chassis Assembly locate on the floor of the Cabinet. When servicing the monitor on a test bench, YOU MUST ISOLATE THE MONITOR FROM THE LINE VOLTAGE WITH AN ISOLATION TRANSFORMER.

- **Remove Marquee Glass**

Switch OFF power to the game. Remove five 1/4" hex-head wood screws holding plastic strip above marquee glass. Set strip aside and carefully lift glass. Store glass carefully to prevent damage.

- **Remove Fluorescent Light Assembly**

Switch OFF power to the game. Remove marquee glass (above). Disconnect the fluorescent light assembly from its power cable. Remove the screws fastening the assembly to the cabinet and lift out the assembly.

---

**WARNING**

If a fluorescent tube drops and it breaks, it will implode!  
Use care in handling.

---

- **Replace Fluorescent Lamp**

Remove marquee glass (above). Remove the fluorescent lamp retainer brackets. Grasp the tube, give it a quarter turn and remove it from its socket. Carefully place a new tube into the socket and turn to reinstall.

- **Remove Speakers**

Switch OFF power to the game. Two speakers are located in the control panel. Remove control panel (see above) to access these speakers.

One speaker is located under the seat. Slide the seat assembly forward, and use the T27 wrench to remove the two tamper proof torque screws from the base of the pedestal assembly. Slide the seat back and remove the two front torque screws. Remove seat assembly to access speaker.

- **Diagnostics Switches**

Open the coin door. The Diagnostics Switches are located on a small bracket inside the coin door.

The Begin Test Switch, closest to the door, activates the game's menu system.

The Volume Up and Volume Down Switches raise and lower the sound level of the game.

The Service Credit Switch, in the back allows credits to be allotted for service testing without affecting the game's bookkeeping total.

## Game Features

**Crusin' USA is a one player game.**

### Starting Up

Switch ON power to the game. A "rug" pattern appears on the CRT screen. When the "rug" pattern ends, the screen shows CHECKING SCRATCH RAMS, and then CHECKING ROMS. The next screen shows CRUIS'N USA REVISION LEVEL, CMOS TEST OK, and the COIN SETTING. The game then moves to the Attract Mode.

Insert the desired amount of coins or tokens. Select which player receives the credit by pressing the appropriate Player Start Button.

**NOTE:** When an error is detected during Start-up Tests, game start-up does not progress, and an error message appears on the screen.

### Player Controls

- **Player Start Button (Green)**  
The start button allows a player to begin game play.
- **Radio Button (Orange)**  
The radio button allows a player to listen to the radio and change stations.
- **View 1-Low Rider Button (Red)**  
View 1 drives the car from inside.
- **View 2-Crus'n Button (White)**  
View 2 drives the car from directly behind.
- **View 3-Sky Hi Button (Blue)**  
View 3 drives the car from an arial view.

## Game Operation

The Crusin' USA Control Switches are located inside the coin door. These switches allow the operator to customize some features of the game.

### CABINET SWITCHES

- The **SLAM TILT SWITCH** detects any forceful vibrations against the Coin Door. This eliminates pounding for free games. It is located on the inside of the coin door.
- The **ON/OFF SWITCH** is located on the right side, top of cabinet.

### CONTROL SWITCHES

- The **BEGIN TEST/ENTER SWITCH** allows you to activate the games Menu System. Press the Begin Test Switch to access the Main Menu. To exit the menu system, select EXIT TO GAME OVER from the Main Menu, then press the Begin Test Switch. This switch will be referred to as SW1 throughout the remainder of this section.
- The **VOLUME UP/+ SWITCH** allows you to cycle forward through the menu selections or adjustment choices, and raises the sound level of the game. This switch will be referred to as SW2 throughout the remainder of this section.
- The **VOLUME DOWN/- SWITCH** allows you to cycle backward through the menu selections or adjustment choices, lowers the sound level of the game. This switch will be referred to as SW3 throughout the remainder of this section.
- The **SERVICE CREDIT/ESCAPE SWITCH** is a special feature switch that allots credit without affecting the game's bookkeeping total. This switch will be referred to as SW4 throughout the remainder of this section.



## Menu System Operation

### OPERATION

All CRUSIN' USA Game Audits, Adjustments, and Diagnostics are options of the Main Menu. Each option, in turn, has its own menu, listing several choices that you may act upon as desired.

Press the SW1 to activate the Main Menu (shown below). Game adjustments, bookkeeping, and diagnostics are all accessible from this menu.

Press the SW2 or SW3 button to cycle through the menu options. Notice that the options are highlighted in sequence. Press SW1 to activate a highlighted option.

**Note:** Only highlighted options can be activated.

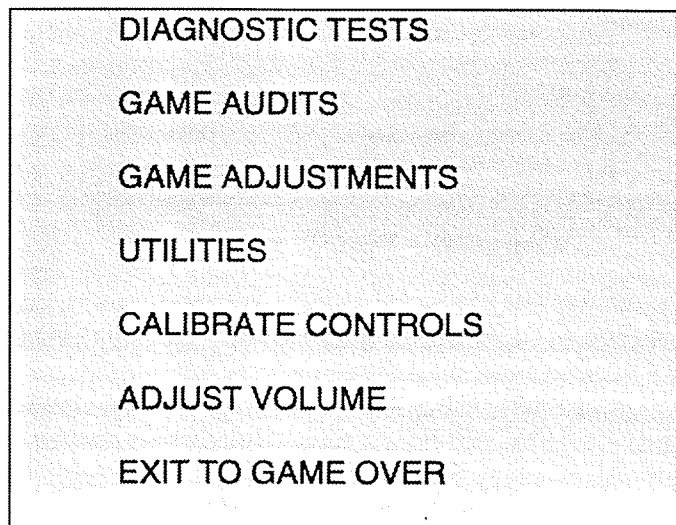

Main Test Menu

## DIAGNOSTIC TESTS

To enter the Diagnostic Tests from the Main Menu, press SW2 to highlight that option, then press SW1 to activate.

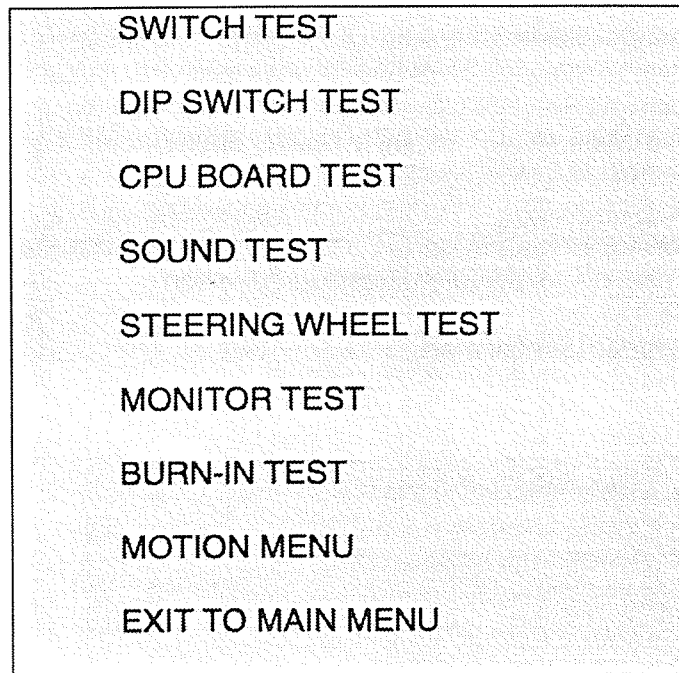

**Diagnostic Test Menu**

### Switch Test

The Switch Test allows the operator to test the switches on the control panel and the coin door.

Select the Switch Test by pressing SW2 to highlight that option; then press SW1 to activate. Pressing a switch on the control panel or coin door causes the corresponding switch location on the screen to light.

Press SW1 to return to the Diagnostic Menu.

### DIP SWITCH TEST

The DIP Switch Test allows the operator to check the position of the two 8-position DIP switches on the CPU Board. The operator can also change the setting of each position of each DIP Switch during this mode.

To enter the test, press SW2 to highlight the DIP Switch Test; then, SW1 to activate. The screen displays a layout of their current settings.

To change a DIP Switch setting, move the switch to the desired setting, then check the screen to verify that the switch now shows the new setting.

Press SW1 to return to the Diagnostic Menu.

### **CPU Board Test**

The CPU Board Test (much like the Start-up Test) allows the operator to check the RAMs and ROMs.

Highlight the CPU Board Test with SW2; then, press SW1 to activate the automatic test of the CPU Board's RAMs and ROMs. When this test is activated, a "rug" pattern appears on the screen. The screen then changes to show the layout of the RAMs and ROMs on the CPU. Any chip that is shown as black with a white outline is part of the CPU and should turn either red or green during the CPU Test. Any chip that is shown as gray with a white outline is not installed in the game. During the test, chips are good, if they turn green; they are faulty, if they turn red.

### **Sound Test**

The Sound Test allows listening to some of the sounds that Crusin' USA is capable of producing. This test also emits a tone for each fault that is detected. After completion of this test, the main menu will be automatically returned to the viewing screen.

### **Monitor Patterns**

The Monitor Patterns Test provides a menu for testing the monitor. Highlight the test with SW2 and activate with SW1. Continue pressing the SW1 button to cycle through the test and automatically return to the Main Menu.

The **COLOR BARS** test fills the screen with several gradated colors to help with red, green and blue level adjustments. Each color should appear sharp and clear.

The **RED, GREEN, and BLUE SCREEN** tests fill the screen with either red, green or blue.

The **CROSSHATCH PATTERNS** test fills the screen with a grid and a series of dots. The grid and the dots should be clear. The dots should appear round.

If any of the Monitor Pattern Tests shows a need for adjustment, use the proper white knobs on the Monitor Board.

### **Burn-in Test**

The Burn-in Test continually repeats the CPU Board Test. Press SW2 to highlight the Burn-in Test; then, press SW1 activate. When the Burn-in Test detects an error, the test stops and displays an error message on the screen. Use this test to find intermittent CPU problems.

To exit this test, switch the game OFF then ON again.

## GAME AUDITS

To enter Game Audits from the Main Menu, press SW2 to highlight that option; then, press SW1 to activate. To advance to the next page of the Game Audit Table, press SW2, or press SW1 to exit.

The Game Audits Table records the game play statistics. The left side of the table names the Audit item; the right side shows the amount of play.

LEFT COIN	0
RIGHT COIN	0
SERVICE CREDITS	0
TOTAL STARTS	0
TOTAL CONTINUES	0
TOTAL ENDS	0
FREE GAMES	0
EVENT	0
UNFINISHED GAMES	0
WATCHDOGS	0
PLAYS UNTIL HIGH SCORE RESET	0

Page 1 of Audit Table

AUTOMATIC SELECTED	0
MANUAL SELECTED	0
VETTE SELECTED	0
LABOMBA SELECTED	0
DEVASTATOR SELECTED	0
ITALIA SELECTED	0
POWER ON TIME	0
GAME TIME	0

Page 2 of Audit Table

SELECT ARIZONA	0
SELECT US 101	0
SELECT LA	0
SELECT IOWA	0
SELECT DEATH VALLEY	0
SELECT USA	0
SELECT BEV HILLS	0
SELECT APPALACHIA	0
SELECT REDWOOD	0
SELECT RUSHMORE	0
SELECT CHICAGO	0

**Page 3 of Audit Table**

START GGATE	0
START SF	0
START US101	0
START REDWOOD	0
START BEVHILLS	0
START LA	0
START DV	0

**Page 4 of Audit Table**

GGATE WINS	0
SANFRAN WINS	0
US101 WINS	0
REDWOOD WINS	0
BEVHILLS WINS	0
LA WINS	0
DEATH VAL WINS	0
ARIZONA WINS	0
GRAND CANYON WINS	0
IOWA WINS	0
CHICAGO WINS	0
INDIANA WINS	0
APPALACHIA WINS	0
DC WINS	0

**Page 5 of Audit Table**

## GAME ADJUSTMENTS

**NOTE:** Game Adjustments are explained in more detail on the following page.

Press SW2 to highlight the Game Adjustment option on the Main Menu; then, press SW1 to activate.

The Game Adjustments option allows the owner/operator to change the Game Pricing and Game Difficulty.

The Game Adjustments Menu offers several options. Press SW2 to highlight an option; then, press SW1 to activate. The activated item provides a setting choice. Press SW3 to change the current setting value; then, press SW1 to lock in the new setting value.

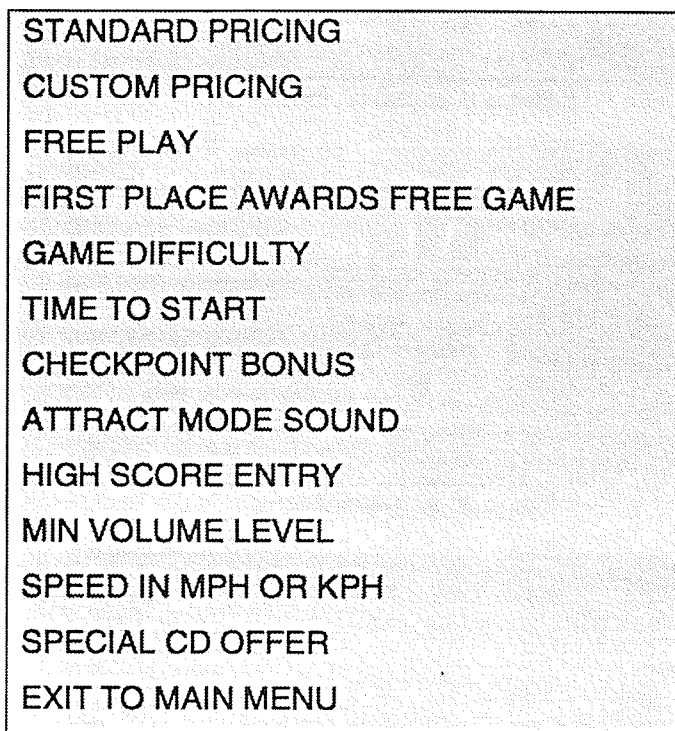

**Game Adjustment Menu**

To exit the Adjustments Menu, press SW2 to highlight EXIT TO MAIN MENU; then, press SW1 to activate.

**Standard Pricing**

Standard Pricing allows the operator to choose any of the "Standard" selections for the Standard Pricing Table.

**Custom Pricing**

Custom Pricing allows the operator to install pricing other than that of the Standard Pricing Table. Custom Pricing also allows the operator to select the amount of credits required to start a game and the amount of credits required to continue a game. This option is adjusted from the Dip Switch Settings.

**Free Play**

This option selects free play. The setting choices for this adjustment are:

- Off (**factory setting**)
- On

**First Place Awards Free Game**

Awards a player a free game on 1st position. The setting choices for this adjustment are:

- On (**factory setting**)
- Off

**Attract-Mode Sounds**

Determines whether the game will make sounds in the attract mode. The settings for the adjustment are:

- On
- Off (factory)

**Speed in MPH or KPH**

This determines speedometer setting in miles per hour or kilometers per hour.

- MPH (**factory setting**)
- KPH

**High Score Entry**

This determines whether the game will allow High Score Entry and Display Table. The setting choices are:

- On (**factory setting**)
- Off

### Standard Pricing Table

Name	Settings Credit/Coin	Left Chute	Center Chute	Right Chute	Fourth Chute
USA 1	1/25¢ (2 to Start; 2 to Continue)	25¢	\$1.00	25¢	
USA 2	1/25¢ (2 to Start; 1 to Continue)	25¢	\$1.00	25¢	
USA 3	1/25¢ (1 to Start; 1 to Continue)	25¢	\$1.00	25¢	
USA 4	1/50¢, 3/\$1.00 (1 to Start; 1 to Continue)	25¢	\$1.00	25¢	
USA 5	1/50¢, 4/\$1.00 (2 to Start; 1 to Continue)	25¢	\$1.00	25¢	
USA 6	1/50¢ (1 to Start; 1 to Continue)	25¢	\$1.00	25¢	
USA 7	1/50¢, 3/\$1.00 (1 to Start; 1 to Continue)	25¢	\$1.00	25¢	
USA 8	1/50¢, 4/\$1.00 (2 to Start; 2 to Continue)	25¢	\$1.00	25¢	
USA ECA	1/25¢, 4/\$1.00 (2 to Start; 2 to Continue)	\$1.00	10¢	25¢	5¢
German 1	1/1DM, 6/5DM	1DM		5DM	
German 2	1/1DM, 7/5DM	1DM		5DM	
German 3	1/1DM, 8/5DM	1DM		5DM	
German 4	1/1DM, 5/5DM	1DM		5DM	
German 5	1/1DM, 6/5DM	1DM		5DM	
German ECA	1/1DM, 2/2DM, 6/5DM	5DM	1DM	2DM	
France 1	2/5F, 5/10F	5F		10F	
France 2	2/5F, 4/10F	5F		10F	
France 3	1/5F, 3/10F	5F		10F	
France 4	1/5F, 2/10F	5F		10F	
France 5	2/5F, 5/10F, 11/2x10F	5F		10F	
France 6	2/5F, 4/10F, 9/2x10F	5F		10F	
France 7	1/5F, 3/10F, 7/2x10F	5F		10F	
France 8	1/5F, 2/10F, 5/2x10F	5F		10F	
France 9	1/3x1F, 2/5F	1F		5F	
France 10	1/2x1F, 3/5F	1F		5F	
France 11	1/3x1F, 2/5F, 5/2x5F	1F		5F	
France 12	1/2x1F, 3/5F, 7/2x5F	1F		5F	
France ECA	1/3x1F, 2/5F, 5/2x5F	1F	10F	5F	
Canada	1/2x25¢, 3/\$1.00	25¢		\$1.00	
Swiss 1	1/1F, 6/5F	1F		5F	
Swiss 2	1/1F, 7/5F	1F		5F	
Swiss 3	1/1F, 8/5F	1F		5F	
Italy	1/500 lire	500 lire		500 lire	
UK1	1/20P, 3/50P	20P		50P	
UK2	2/20P, 5/50P	20P		50P	
UK ECA	1/20P, 3/50P, 7/£1.00	£1.00	20P	50P	10P
UK Elec w/CCU	1/30P, 2/50P, 4/£1.00	£1.00		CCU	
Spain 1	1/100P, 6/500P	100P		500P	
Spain 2	1/4X25, 1/100, 2/200, 5/500	25P	100P	200P	500P
Australia 1	1/3x20¢, 2/\$1.00	20¢		\$1.00	
Australia 2	1/5x20¢, 1/\$1.00	20¢		\$1.00	
Japan 1	1/100 yen	100 yen		100 yen	
Japan 2	2/100 yen	100 yen		100 yen	
Austria 1	1/5 schilling, 2/10 schilling	5 schilling		10 schilling	
Austria 2	1/2x5 schilling, 3/2x10 schilling	5 schilling		10 schilling	
Belgium 1	1/20F	20F		20F	
Belgium 2	3/20F	20F		20F	
Belgium 3	2/20F	20F		20F	
Belgium ECA	1/20F	50F	5F	20F	
Sweden	1/3x1 krona, 2/5 krona	1 krona		5 krona	
New Zealand 1	1/3x20¢	20¢		20¢	
New Zealand 2	1/2x20¢	20¢		20¢	
Netherlands	1/1HFI, 3/2.5HFI	1HFI		2.5HFI	
Finland	1/1 markka	1 markka		1 markka	
Norway	1/2x1 krone, 3/5x1 krone	1 krone		1 krone	
Denmark	1/2x1 krone, 3/5 krone, 7/2x5 krone	1 krone		5 krone	
Antilles	1/25¢, 4/1 guilder	25¢		1 guilder	
Hungary	1/2x10 forint, 3/2x20 forint	10 forint		20 forint	



## Custom Pricing

- RETURN TO MAIN MENU
- (1) LEFT CHUTE (1) UNITS
- (1) RIGHT CHUTE (2) UNITS
- (1) CHUTE (3) UNITS
- (1) CHUTE (4) UNITS
- (2) UNITS/CREDIT
- (3) UNITS/BONUS
- (4) MINIMUM UNITS REQUIRED
- (5) CREDITS TO START
- (6) CREDITS TO CONTINUE
- (7) COIN PAGE HELP
- (8) SHOW CREDIT FRACTIONS
- (9) COINS PER DOLLAR
- (10) MAXIMUM CREDITS

- (1) Coins inserted accumulate units. This adjustment specifies the number of units given for each coin in the fourth chute (see "units/credit")
- (2) This is the number of coin units required to buy one credit.
- (3) One bonus credit is awarded after this many coin units have accumulated.
- (4) No credits will be awarded until this many coin units have accumulated.
- (5) Each player needs this many credits to begin a game.
- (6) Each player needs this many credits to continue a game.
- (7) Whenever standard pricing is used, a corresponding message is displayed on the credits screen. Setting this to no disables the message.
- (8) When set to yes, fractional credits will be seen on the credits screen.
- (9) The detailed bookkeeping screen shows total collections based on this many coins per dollar. (Set to zero to disable the display of money totals.)
- (10) This is the limit for the credits counter. Additional coins inserted will be lost. Factory setting is 30.

## UTILITIES

Press SW2 to highlight the Utilities option on the Main Menu; then, press SW1 to activate.

The Utilities Menu allows the owner/operator to clear the games bookkeeping memory and to install a custom message.

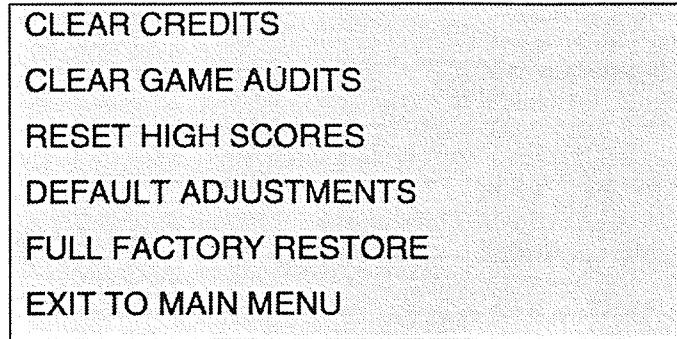

**Utilities Menu**

Press SW2 to highlight an item from the Utilities Menu; then, press SW1 to activate. After an item has been activated, you are given the option of resetting that item or not. For example:

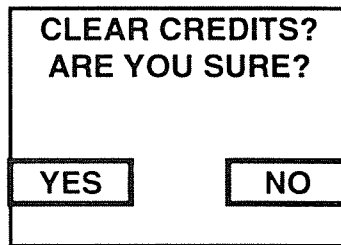

Press SW3 to choose YES or NO; then, press SW1 to lock your choice and to return to the Utilities Menu.

To exit the Utilities Menu, press SW3 to highlight EXIT TO MAIN MENU; then, press SW1 to activate selection.

## Troubleshooting

### PROBLEM

### POSSIBLE SOLUTION

NO PICTURE OR DISTORTED PICTURE.

Check for faulty video board or monitor.  
Check for disconnected video signal cable.

TURN GAME ON & NOTHING HAPPENS.

Check line fuse. Check for +5Vdc at pins C, D, 3, and 4 of the JAMMA Connector.

NO SOUND.

Check the speaker and speaker connection to pins L and 10 on the JAMMA Connector. Check volume control setting. Check for +12Vdc at pins F and 6 on the JAMMA Connector. Check interboard wiring on CPU Board. Check sound fuses.

NO GENERAL ILLUMINATION.

Check the 1.0A., F.B. fuse located in the Power Chassis Assembly.

MOVE JOYSTICK, BUT PLAYER DOES NOT MOVE.

Check for open wires between the Joystick and CPU Board. Check for contamination on joystick switch contacts and CPU Board pins. Check for proper ground.

PRESS START BUTTON AND NOTHING HAPPENS.

Check for open wires between the button and CPU Board. Check for contamination on CPU Board pins or the button switch blade contacts. Check for proper ground.

NO CREDIT GIVEN WHEN COINS ARE INSERTED.

Check for contamination on coin switch contacts. Check for an open wire between Coin Switch 1 and pin 16 on the JAMMA Connector or Coin Switch 2 and pin T of the JAMMA Connector.

TOO MANY CREDITS FOR NUMBER OF COINS INSERTED.

Check Game Pricing setting. Check for a Short between pins T & 16 on the JAMMA Connector.

GAME STAYS IN THE TEST MODE.

Check that the Test Switch in the coin door and the Test Switch (Position 8) on DIP Switch 2 are set to Off.

# Notes...

A series of 25 horizontal dotted lines for writing notes.

# CRUIS'N USA

SINGLE SIT DOWN

SECTION  
TWO

---

**Parts Information**

## Cabinet Hardware

Cabinet Assembly	A-17889.1
Lock Retainer Plate	01-7264
Upper Door Lock Cam	01-8989
Leg Leveler Plate	01-9155
Lock Plate	01-11285
Door Bracket	01-11291
Shaft Caster	02-4404
20" Vent Hole Cover	03-7602
Leg Adjuster, 3.0"	08-7377
Door Cam Lock	20-6542-TB
Caster Wheel	20-9627
Coin Door Assembly	09-74000-33
Tamper Proof Screw Tool, T-20	20-9620
#555 Bulb, 6.3v	24-8768
Marquee	31-2005
Marquee Retainer	03-8252-5
Marquee Glass	08-7852

## Electronic Rack

Electronic Rack	A-19301
CPU Sound Board Assembly	A-19233-40033
Power Supply Switcher Assy.	A-15202-1
Steering Wheel Driver Assy.	A-18004-40033
Ribbon Cable, 20-pin	5795-10937-06
Ribbon Cable, 20-pin	5795-14465-60

## Speakers

Speaker, 4 $\Omega$ , Tweeter, 15w	5555-12924-00
Speaker, 4 $\Omega$ , 6", 25w	5555-12929-00
Speaker Grill	01-12816

## Transformer Assembly

Power Pack Assembly	A-19244
---------------------	---------

## Dash Assembly

Dash Assembly	A-19271
---------------	---------

## Fluorescent Lamp Assembly

Fluorescent Housing & Bracket	A-15890
Lamp Lock	03-8327
18" Fluorescent Bulb, 15w	24-8809

## Monitor

Monitor, 25"	5675-14041-00
Monitor Bezel	03-9098
Monitor Support Bracket	A-19501

## Cables

Line Voltage Cable Assembly	A-19248
Transformer Jumper Cable	H-13378
G.I. Jumper Cable	H-15945
Fluorescent Lamp Cable	H-16303
Switcher Power Cable	H-17914
Control Cable	H-18175
Line Voltage Cable	H-18191.1
Four Speed Shift Cable	H-18737
AC Power Pack Cable	H-19251
Cable Bass Speaker	H-19256
Main Harness Cable	H-19302
Video Signal Cable	H-19357-3

## Seat Assembly

Pedestal w/Seat Assembly	A-19304
--------------------------	---------

# A-15202-1 Power Supply Switcher Assembly

Item	Part Number	Description
1.	H-17914	Switch Power Cable
2.	20-9920	Power Supply Switcher/UL
3.	01-12162	Shield for Switcher
4.	H-15206	Ground Jumper
5.	01-10500	Power Supply Mounting Bracket

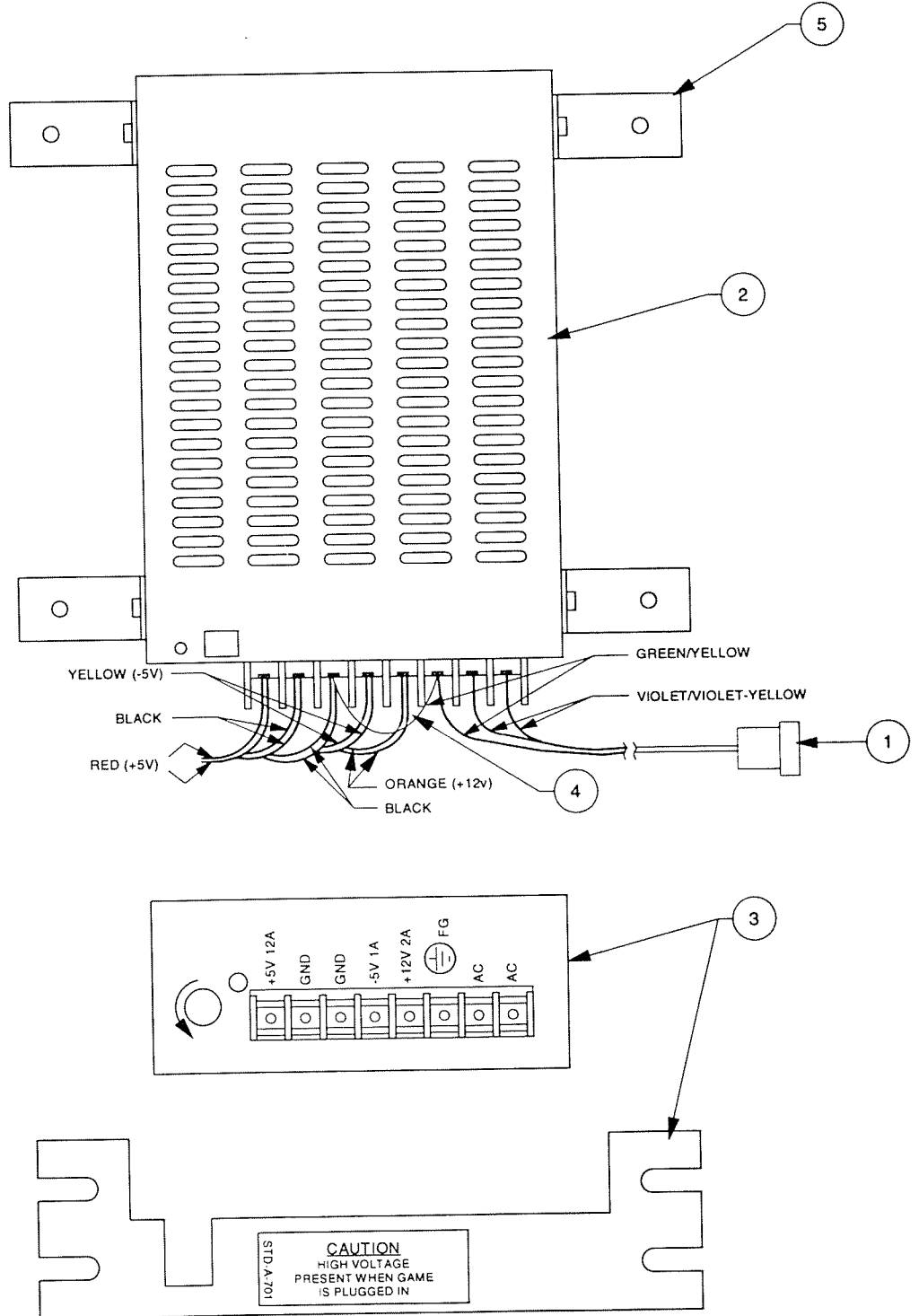

# A-18004-40033

## Wheel Driver Board Assembly

Part Number	Designator	Description	Part Number	Designator	Description
<b>A-18005</b>		Wheel Driver Board Assembly			
5340-12958-00	U3	I.C. 26LS31	5043-08980-00	B1-B4, B10-B19, B7-B9, C31, C8, C9	Capacitor, 01μF,50v(+80,-20%)
5340-12959-00	U7	I.C. 26LS32	5043-08996-00	C27, C29, C32, C35-C37	Capacitor, .1μF, 50v,(±20%)Ax.
5311-12538-00	U18	I.C. 74HC14	5048-12577-00	C28	Capacitor, .47μF, 50v, Axial
5311-14067-00	U13, U17	I.C. 74HC245	5048-13375-00	C10-C25	Capacitor, 100PF, 50v,10% Ax.
5311-14068-00	U4, U10, U14	I.C. 74HC574	5048-11031-00	C1, C2, C39	Capacitor, .001μF,50v,10% Ax.
5311-10948-00	U9	I.C. 74HC138	5040-09343-00	C30, C33	Cap. Electrolytic , 10μF, 20v
5430-13598-00	U1	I.C. 75160B	5070-08919-00	D1	Diode, 1N4148
5372-13323-00	U2	I.C. ADC0848	5075-09135-00	D4	Zener Diode, 10v, 1N4740A
5371-14070-00	U5	I.C. DAC08, D-A Converter	5075-12824-00	D7, D8	Zener Diode, 12v, 1N4742A
5370-12602-00	U11, U12	I.C. ULN2064B	5075-14066-00	D2, D3	Zener Diode, 15v, 1N4744A
5700-12047-00	U8, U19	Solder Socket , 24-pin, 3"			
5370-14069-00	U6	I.C. LM12, Power OP-AMP			
5160-10269-00	Q1, Q2	Trans. 2N3904			
5100-13945-02	BR1, BR2	Bridge, 4.0A.			
5040-08986-00	C3	Cap., Electrolytic, 100μF, 10v			
5040-12298-00	C36, C38	Cap., Electrolytic, 100μF, 40v			
5040-13417-00	C4-C7	Cap., Electrolytic, 10,000μF			
5791-10862-09	P1	Connector, 9-pin Header .156			
5791-10862-02	P10	Connector, 2-pin Header .156			
5791-10862-04	P2	Connector, 4-pin Header .156			
5791-12461-04	P12	Connector, 4-pin Header .100			
5791-09437-00	P3	Connector, 20-pin Rib. Header			
5791-12461-11	P5	Connector, 11-pin Header .100			
5791-10850-00	P6	Connector, 26-pin Rib. Header			
5791-12461-10	P7, P8	Connector, 10-pin Header .100			
5791-12516-00	P4	Connector, 34-pin Ribbon			
5633-13826-00	-	Fuse Clips 5x20mm			
5070-09045-00	D5, D6	Diode, MR501			
5551-09822-00	L1	Inductor, 4.7μH			
5671-13732-00	LED1	LED, Red			
5010-10428-00	R112, R113	Resistor, 470Ω, 1w, 5%			
5019-09362-00	SR1-SR3	Resistor, 4.7KΩ SIP			
5705-14076-00	-	Heatsink, 4 Lead TO-3			
5701-14092-00	-	Thermal Pad For Power AMP			
4006-01003-08	-	Mach. Screw, 6-32 x 1/2"			
4008-01003-08	-	Mach. Screw, 8-32 x 1/2"			
4406-01128-00	-	Nut, 6-32 KEPS			
4408-01128-00	-	Nut, 8-32 KEPS			
03-9129	-	Nylon Spacer			
<b>A-18005-AI</b>		Wheel Driver Assy., Auto-Insert			
5010-14093-00	R23, R47, R116, R120	Resistor, 0 Ω, 1/8w, 5%			
5010-13363-00	R121	Resistor, 100 Ω, 1/8w, 5%			
5010-13844-00	R43, R44, R48, R49, R52	Resistor, 100K Ω, 1/8w, 5%			
5010-13593-00	R30, R33, R34, R36-R39, R46, R51, R55, R59, R63-R66, R115	Resistor, 10K Ω, 1/8w, 5%			
5010-09134-00	R42	Resistor, 150K Ω, 1/4w, 5%			
5010-13594-00	R26	Resistor, 1K Ω, 1/8w, 5%			
5010-08931-00	R31, R35	Resistor, 1K Ω, 1/2w, 5%			
5010-13372-00	R19	Resistor, 220 Ω, 1/8w, 5%			
5010-09999-00	R67-R74	Resistor, 2K Ω, 1/4w, 5%			
5010-13596-00	R45, R50, R54, R58, R62	Resistor, 33K Ω, 1/8w, 5%			
5010-13364-00	R1-R16, R76-R83, R85-R92, R122	Resistor, 33 Ω, 1/8w, 5%			
5010-13371-00	R114	Resistor, 330 Ω, 1/8w, 5%			
5010-13365-00	R21, R24, R25, R27, R119	Resistor, 4.7K Ω, 1/8w, 5%			
5010-14065-00	R41	Resistor, 75KΩ, 1/8w, 5%			
5731-14094-00	F1, F2	Fuse, 4ASB, 5x20mm			
5735-13853-00	F3	Fuse, 2ASB, 5x20mm			



# A-18004-40033 Wheel Driver Board Assembly

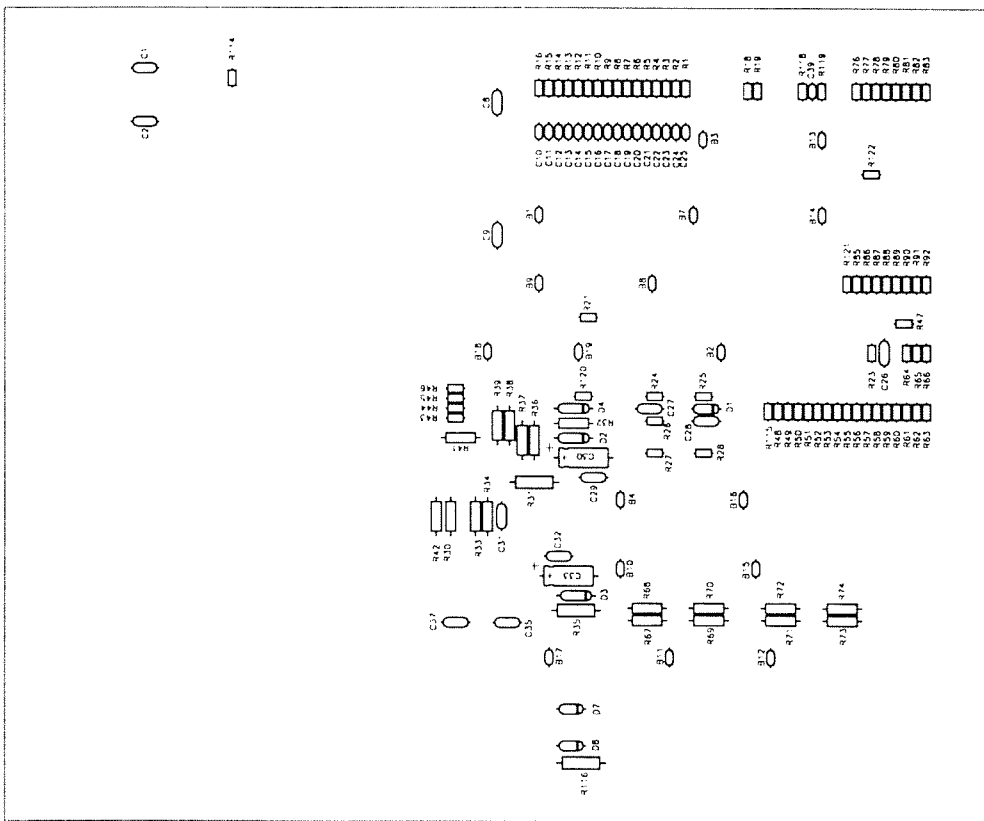
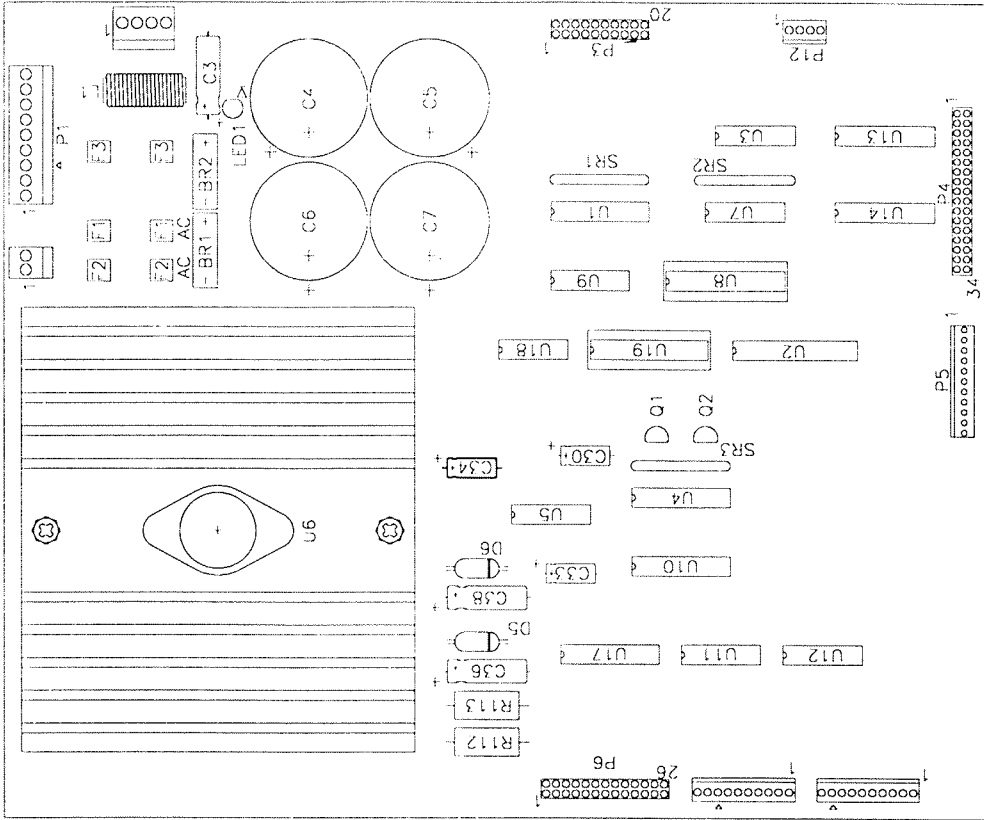

A-18005.1 Wheel Driver Board Assembly

A-18005.1-AI Wheel Driver Assembly, Auto -Insert

# A-19233-40033

## CPU/Sound Board Assembly

Part Number	Designator	Description	Part Number	Designator	Description
<b>A-19234</b>					
5040-13417-00	C191, C192	CPU Sub-Assembly	5521-13806-05	U89	Xtal Oscillator, 40mHz
5370-12602-00	U122	Cap Electro, 10,000MF, 35v	5521-13603-01	U96	Xtal Oscillator, 50mHz
5070-09054-00	D1-D4	Darlington Switch	520-13301-00	U1	Y10H 10mHz
5370-13419-00	U78, U81	Diode, 1N4004	5671-13732-00	D5-D7	Light Emitting Diode, Red
5370-12730-00	U79, U80	TDA2030	5556-14181-00	L35-L37	FB700
5340-13304-00	U35, U41, U42	TL084	5100-13945-02	BR1	Bridge 4A
5340-13597-00	U85, U87	2K x 8 SRAM	5733-14113-00	F1, F2	Fuse Holder
5340-12558-00	U31	62256, 32Kx8 BIT SRAM, 55nS	5700-12047-00	U38, U43,	I.C. Socket, 24-pin, .3"
5371-13299-00	U61	8KX8 CMOS SRAM, 120nS	5700-12088-00	U2, U54, U111, U114	I.C. Socket, 32-pin, .6"
5372-12901-00	U130	AS1851	5881-12315-00	B1	Battery Holder
5340-12958-00	U92	ADC0844-8 BIT A TO D	5645-09025-00	U97, SW3	DIP Switch, 16-Pin
5340-12959-00	U91	Converter w/4 CH, Multiplexer	5641-12551-00	SW1	Switch PCB Mount MC
5344-14130-00	U45, U58	AM26LS31 - Quad Differential	5791-10862-02	P1, P2	Connector, C156x2 2-pin
5434-12255-00	U30	Line Drivers	5791-12461-04	P5	Connector, C100x5 5-pin
5283-10551-00	U62	AM26LS32 - Quad Differential	5791-12461-05	P3, P7	Connector, C100x5 5-pin
5286-14178-00	U55	Line Receivers	5791-10862-07	P4	Connector, C156x7 7-pin
5280-09309-00	U82	IDT7204, CMOS Parallel FIFO	5791-12461-12	P9	Connector, C100x12 12-pin
5311-12538-00	U63	4K x 9 BIT, 20nS	5791-12461-13	P11	Connector, C100x13 13-pin
5281-09500-00	U36	Max691, Power ON Reset/	5791-09437-00	P8	Connector, 20-pin Ribbon, .1"
5281-09487-00	U64	WATCHDOG/CMOS CTL Circuit	5791-10850-00	P10	Connector, 26-pin Ribbon, .1"
5311-10948-00	U34	74F00	5705-12638-00	HS1, HS2	Heatsink 5299B
5317-12023-00	U88	74AS02 - ALS TTL Quad 2	5791-12994-00	J6	Header
5311-12043-00	U40, U51	Input NOR GATE	4004-01005-06	-	Mach. Screw, 4-40 x 3/8"
5430-14290-00	U126-U129	7407-TTL Hex Buffer w/ High	4404-01124-00	-	Nut 4-40 KEPS
5317-12208-00	U44, U46, U48, U49, U98,	Voltage Output	<b>A-19331</b>		
	U107, U108, U113	74HC14	5052-14149-00	C173, C174	CPU Surface Mount Sub-Assembly
5311-12287-00	U33, U39,	74LS32	5052-14366-00	C88, C118, C159,	Cap., 0805 22PF, 10%, 50v
	U50, U93, U104,	74LS74		C160, C164, C197, C198, C212,	Cap., 0805, 47PF, 10%, 50v
	U105, U109, U112,	74HC138		C224-C226, C229-C234,	
	U116, U119, U120,	74ALS138-ALS TTL 3/8 Decoder		C255, C274, C275, C277,	
	U121, U125	74HC174		C279, C278, C299-C303	
	U32, U47,	74176B-Bidirectional Transceiver	5052-14169-00	C115, C151-C153,	Cap., 0805, 100PF, 10%, 50V
	U65, U66, U86, U110	74ALS245, ALS TTL Octal		C155-C157, C235, C237-C239,	
	U37, U53,	Bus Transceiver		C241, C242, C256-C273,	
		74HC541 - HC TTL Octal Buffer		C280-C297	
5317-12211-00			5052-14367-00	C123, C190	Cap., 0805PF, 5%, 50v
5317-12212-00		74ALS574 - ALS TTL Octal	5052-14167-00	C169	Cap., 0805, 470PF, 20%, 50v
		Flip-Flop	5052-14171-00	C95, C98, C111, C128	Cap., 0805, 680PF, 5%, 50v
5430-13598-00	U117, U124	74ALS541 - ALS TTL Octal Buffer	5052-14168-00	C94, C96, C99, C110,	Cap., 0805, 1000PF, 5%, 50v
5250-13303-00	U1085	74ALS574 - ALS TTL Octal	5052-14350-00	C97, C100, C129	Cap., 0805, 3900PF, 5%, 50v
5250-13302-00	U1010	Flip-Flop	5052-14164-00	C109	Cap., 0805, 4700PF, 5%, 50v
5521-13806-06	U67	75160 - Octal Interface Bus Trans.		C1-C8, C10, C11,	Cap., 0805, 0.01MF, 10%, 50v
		LM79L05T		C13-C16, C18, C19, C21-C31,	
		LM78L05T		C33-C41, C43-C48, C52, C54,	
		Xtal Oscillator, 33mHz		C55, C57-C64, C66, C67, C69,	
				C70, C72-C75, C77-C80, C83,	

# A-19233-40033

## CPU/Sound Board Assembly

(Continued)

Part Number	Designator	Description	Part Number	Designator	Description
5052-14164-00	C85, C87, C90, C101, C102, C104, C105, C107, C116, C117, C120, C131, C132, C135-C138, C140, C142-C144, C150, C162, C163, C166, C175, C178-C187, C193-C196, C199-C209, C213-C218, C221-C223, C236, C244-C251, C305, C306	Cap., 0805, 0.01MF, 10%, 50v	5020-14373-00	R414, R425, R426, R428-R432, R434, R435, R437-R467, R472, R484-R487, R491, R493, R494, R497, R499, R501, R508-R524, R527, R528, R532, R537-R552, R567-R586, R632, R637, R688, R691, R694, R696, R697, R699, R700, R702, R703, R705, R726-R732, R734, R736, R738, R740, R742, R744, R746, R748, R751, R753, R754, R756, R759, R762, R764, R533	Resistor, 0805 33 Ω, 1/10w, 5%
5052-14435-00	C56, C71, C84, C89, C103, C119, C165, C219	Cap., 0805 10PF, 5%, 50v	5020-14161-00	R26, R28, R30, R32, R34, R43-R49	Resistor, 0805 47 Ω, 1/10w, 5%
5052-14385-00	C148	Cap., 0805 0.022MF, 10%, 50v	5020-14161-00	R78-R87, R148, R215, R218, R219, R342, R344-R356, R358, R369, R420, R422, R423, R482, R483, R554, R556	Resistor, 0805 47 Ω, 1/10w, 5%
5052-14369-00	C145-C147	Cap., 0805 0.047MF, 10%, 50v		R25, R77, R123, R150, R178, R217, R341, R427, R436, R601, R609, R647	
5052-14165-00	C65, C81, C82, C91, C93, C106, C112-C114, C121, C124, C125, C130, C133, C139, C141, C149, C167, C170, C176, C210, C211, C254	Cap., 0805 0.1MF, 20%, 50v		R737, R739, R743, R749	
5051-14150-00	C108, C168	B5328 0.22 MF TANT ±10%, 50v	5020-14152-00	R488	Resistor, 0805 100 Ω, 1/10w, 5%
5052-13633-00	C1109, C1130, C1032	Cap., 1206, 0.33MF, ±20%, 50v	5020-14374-00	R343, R610, R650	Resistor, 0805 220 Ω, 1/10w, 5%
5051-14371-00	C126, C171, C172, C189	Cap., 1MF, ± 20%, 35v TANT	5020-14160-00	R489, R628, R630, R634, R635, R639, R641, R651, R654, R656, R658, R659, R662, R663, R666, R667, R670, R673, R674, R677, R678, R680, R681, R685, R686, R709, R710, R712, R713, R715, R716, R718, R720	Resistor, 0805 470 Ω, 1/10w, 5%
5051-14151-000	C9, C12, C17, C32, C42, C68, C86, C92, C134, C154, C158, C161, C177, C220, C227, C20, C243, C253, C276, C278, C304	Cap., 10MF, ±20%, 16v TANT	5020-14377-00	R504, R560, R565	Resistor, 0805 487 Ω, 1/10w, 1%
5051-14148-00	R2, R3, R6, R7, R9, R11, R16, R18, R19, R21, R23, R24, R97, R192, R193, R238, R251, R372, R761	Cap., 22MF, ±20%, 16v Resistor, 0 Ω, 1/10w	5020-14378-00	R473, R595	Resistor, 0805 680 Ω, 1/10w, 5%
5020-14349-00	R12-R14, R35-R42, R60, R61, R63, R64, R66-R76, R89, R90, R92, R93, R96, R98, R99-R104, R107, R110, R11, R112, R114-R122, R124-R147, R149, R153-R155, R157-R159, R161-R163, R166-R168, R172-R175, R180-R188, R191, R195, R197-R200, R205, R206, R208, R209, R211, R212, R222, R223, R225, R226, R228, R229, R231-R233, R235, R239, R241-R243, R245, R247, R250, R254-R258, R260, R264-R273, R276, R277, R279, R282, R284, R295-R299, R301, R304, R306-R310, R312, R314-R333, R335, R357, R359-R368, R370, R373-R375, R380-		5020-14379-00	R475, R505, R561, R566, R619, R623, R626	Resistor, 0805 1K Ω, 1/10w, 1%
5020-14372-00	R337, R553	Resistor, 15 Ω, 1/10w, 5%	5020-14380-00	R506, R557, R562, R602-F605, R607, R608, R640, R643	Resistor, 0805 2K Ω, 1/10w, 1%
5020-14373-00	R12-R14, R35-R42, R60, R61, R63, R64, R66-R76, R89, R90, R92, R93, R96, R98, R99-R104, R107, R110, R11, R112, R114-R122, R124-R147, R149, R153-R155, R157-R159, R161-R163, R166-R168, R172-R175, R180-R188, R191, R195, R197-R200, R205, R206, R208, R209, R211, R212, R222, R223, R225, R226, R228, R229, R231-R233, R235, R239, R241-R243, R245, R247, R250, R254-R258, R260, R264-R273, R276, R277, R279, R282, R284, R295-R299, R301, R304, R306-R310, R312, R314-R333, R335, R357, R359-R368, R370, R373-R375, R380-				

# A-19233-40033

## CPU/Sound Board Assembly

(Continued)

Part Number	Designator	Description
5020-14172-00	R261-R263, R274, R275, R278, R280, R281, R283, R300, R302, R303, R305, R311, R313, R334, R336, R376, R377-R379, R415, R421, R468, R469, R471, R480, R481, R490, R492, R495, R496, R498, R500, R502, R525, R526, R529-R531, R534, R555, R587-R594, R606, R611-R618, R622, R629, R631, R633, R636, R638, R642, R644-R646, R652, R653, R655, R657, R660, R661, R664, R665, R668, R669, R671, R672, R675, R676, R679, R682-R684, R687, R689, R690, R692, R693,	Resistor, 0805 4.7K $\Omega$ , 1/10w, 5%
5020-14172-00	R695, R698, R701, R704, R706-R708, R711, R714, R717, R719, R721, R722, R755, R757, R758, R760, R470	Resistor, 0805 4.7K $\Omega$ , 1/10w, 5%
5020-14173-00	R288, R289, R290-R294, R338-R340, R419	Resistor, 0805 6.19K $\Omega$ , 1/10w, 1%
5020-14158-00	R477, R478, R559, R564, R625	Resistor, 0805 8.2K $\Omega$ , 1/10w, 5%
5020-14383-00	R476	Resistor, 0805 9.09K $\Omega$ , 1/10w, 1%
5020-14156-00	R648, R649, R723-R725, R733, R735, R741, R745, R747, R750, R752	Resistor, 0805 10K $\Omega$ , 1/10w, 5%
5020-14384-00	R474	Resistor, 0805 11K $\Omega$ , 1/10w, 1%
5020-14381-00	R416, R417, R479, R535, R596, R597	Resistor, 0805 22K $\Omega$ , 1/10w, 5%
5020-14174-00	R418, R536	Resistor, 0805 47K $\Omega$ , 1/10w, 5%
5349-14131-00	U94, U95, U101, U102	256K x 8 BIT VRAM, 70nS
5349-13599-00	U69-U76	44C1000, 1Megx4BIT CMOSDynamic RAM, 60nS
5349-14132-00	U56, U57, U59, U60	6226X, 128Kx8BIT Fast Static RAM 20nS
5400-13298-00	U1	ADSP2105
5410-13465-00	U68	IC, VR1 ASIC
5285-14342-00	U83, U84	74ALS374 20PSOL
5400-14129-00	U90	DSP TMS320C31, 50MHZ
5556-14348-00	L1-L34, L38, L39, R765	Inductor, FB0805
5020-14347-00	R286, R424, R433	Resistor, 0805, 4.75K $\Omega$ , 1/10w, 1%

# A-19233-40033 CPU/Sound Board Assembly

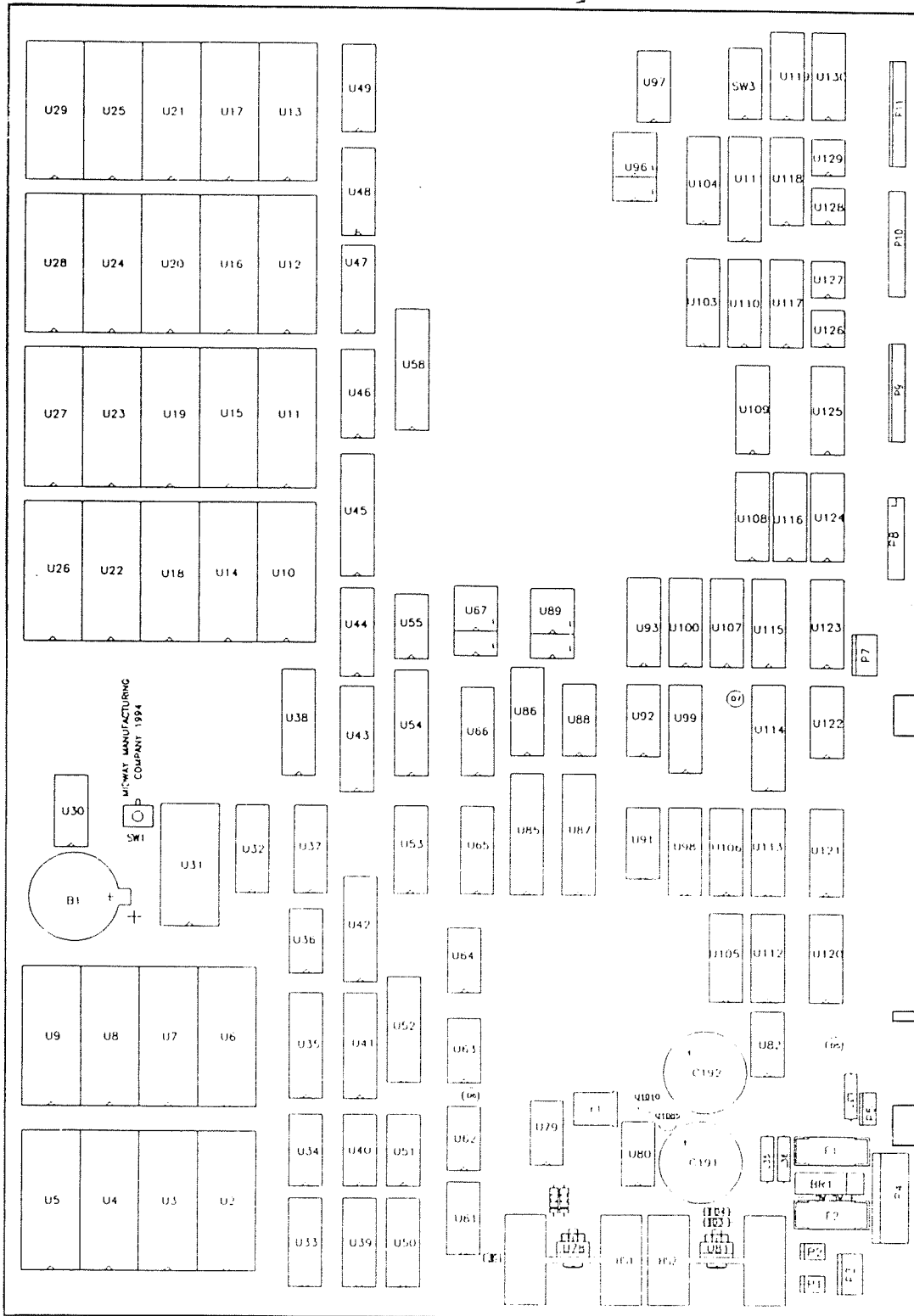

A-19234 CPU Sub-Assembly

# A-19233-40033 CPU/Sound Board Assembly

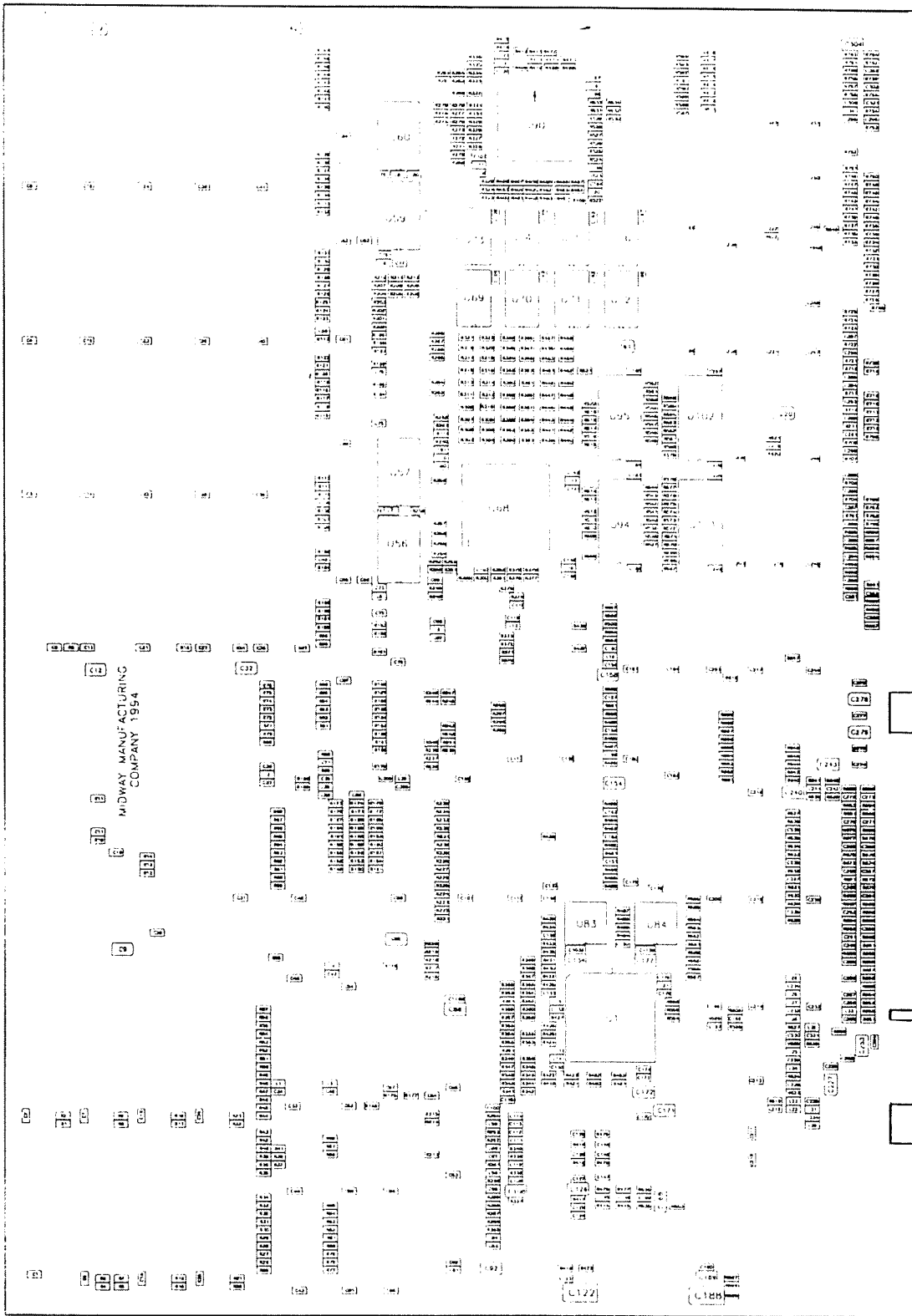

A-19331 CPU Surface Mount Sub-Assembly

## A-19271 Dash Assembly

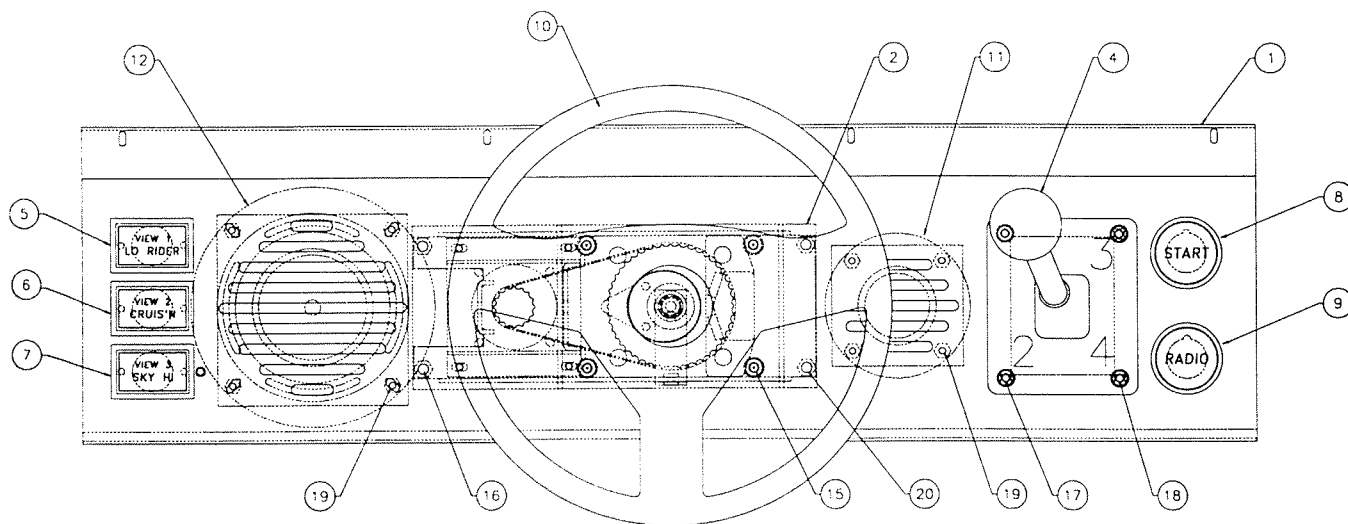

Item	Part Number	Description
1.	A-19502	Dash Plate
2.	A-19503	Steering Mech. Mtg. Plate
3.	03-7655-8	Clamp Cable, 1/2"
4.	20-10117	4-Speed Shifter
5.	20-10127-1	Switch P/B Rectangular, Red
6.	20-10127-2	Switch P/B Rectangular, White
7.	20-10127-3	Switch P/B Rectangular, Blue
8.	20-10129-1	Switch P/B Circular Med, Start
9.	20-10129-2	Switch P/B Circular Med, Radio
10.	20-10134	Steering Wheel Assembly
11.	5555-12924-00	Speaker, 4, Tweeter 15w
12.	5555-12856-00	Speaker, 5-1/4", 4, 25w
13.	H-18175	Control Cable
14.	H-18737	Four Speed Shift Cable
15.	4020-01100-20	TR, 1/4-20 x 1-1/4"
16.	4420-01119-00	Nut, 1/4-20 ESN/NE
17.	4310-01123-10B	Bolt, 10-24 x 5/8 CB
18.	4410-01128-00	Nut, 10-24 KEPS
19.	4408-01128-00	Nut, 8-32 KEPS
20.	4320-01124-12	Bolt, 1/4-20 x 3/4"

# A-19288 Monitor Cover Assembly

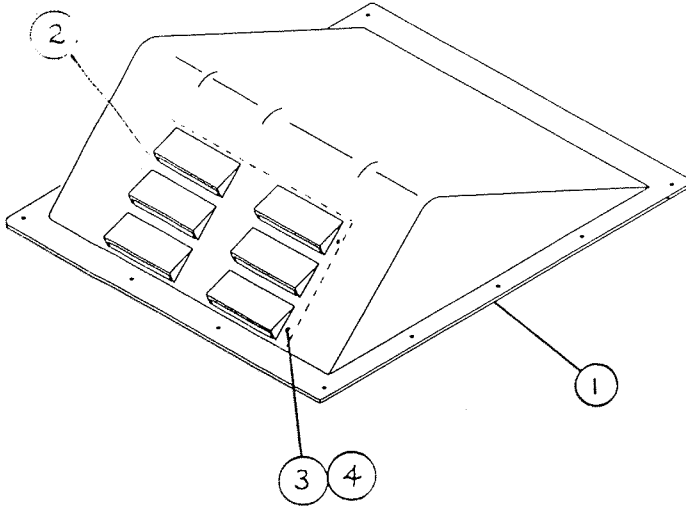

Item	Part Number	Description
1.	03-9099	Monitor Cover
2.	01-13419	Shield Monitor Cover
3.	07-6700	Pop Rivet, 1/8" Dia.
4.	4700-00096-00	Flatwasher, 1/8x5/16x21ga.



# CRUIS'N USA

SINGLE SIT DOWN

SECTION  
THREE

---

**Schematics and Wiring Diagrams**

**NOTES**

A series of horizontal dotted lines for writing notes.

## JAMMA CHART

<i>FUNCTION</i>	<i>WIRE COLOR</i>	<i>PIN</i>	<i>PIN</i>	<i>WIRE COLOR</i>	<i>FUNCTION</i>
Ground	Black	1	A	Black	Ground
Ground	Black	2	B	Black	Ground
+5VDC	Red	3	C	Red	+5VDC
+5VDC	Red	4	D	Red	+5VDC
-5VDC	Yellow	5	E	Yellow	-5VDC
+12VDC	Orange	6	F	Orange	+12VDC
	Key	7	H	Key	
Coin Counter 1	Brown	8	J	Brown-Red	Coin Counter 2
	N/C	9	K	N/C	
	N/C	10	L	N/C	
	N/C	11	M	N/C	
Video Red	Red	12	N	Green	Video Green
Video Blue	Brown	13	P	White	Video Sync
Video Ground	Shield	14	R	White-Gray	Service
Test	Black-Blue	15	S	Black-Green	Slam
Coin 1	Black-Brown	16	T	Black-Red	Coin 2
Start	White	17	U	N/C	
Black	White-Black	18	V	N/C	
Black	White-Brown	19	W	N/C	
Black	White-Red	20	X	N/C	
	N/C	21	Y	N/C	
Black	White-Yellow	22	Z	N/C	
Black	White-Green	23	a	N/C	
Black	White-Blue	24	b	N/C	
Black	White-Violet	25	c	N/C	
	N/C	26	d	N/C	
	N/C	27	e	Black	Ground
Ground	Black	28	f	Black	Ground

# POWER WIRING DIAGRAM

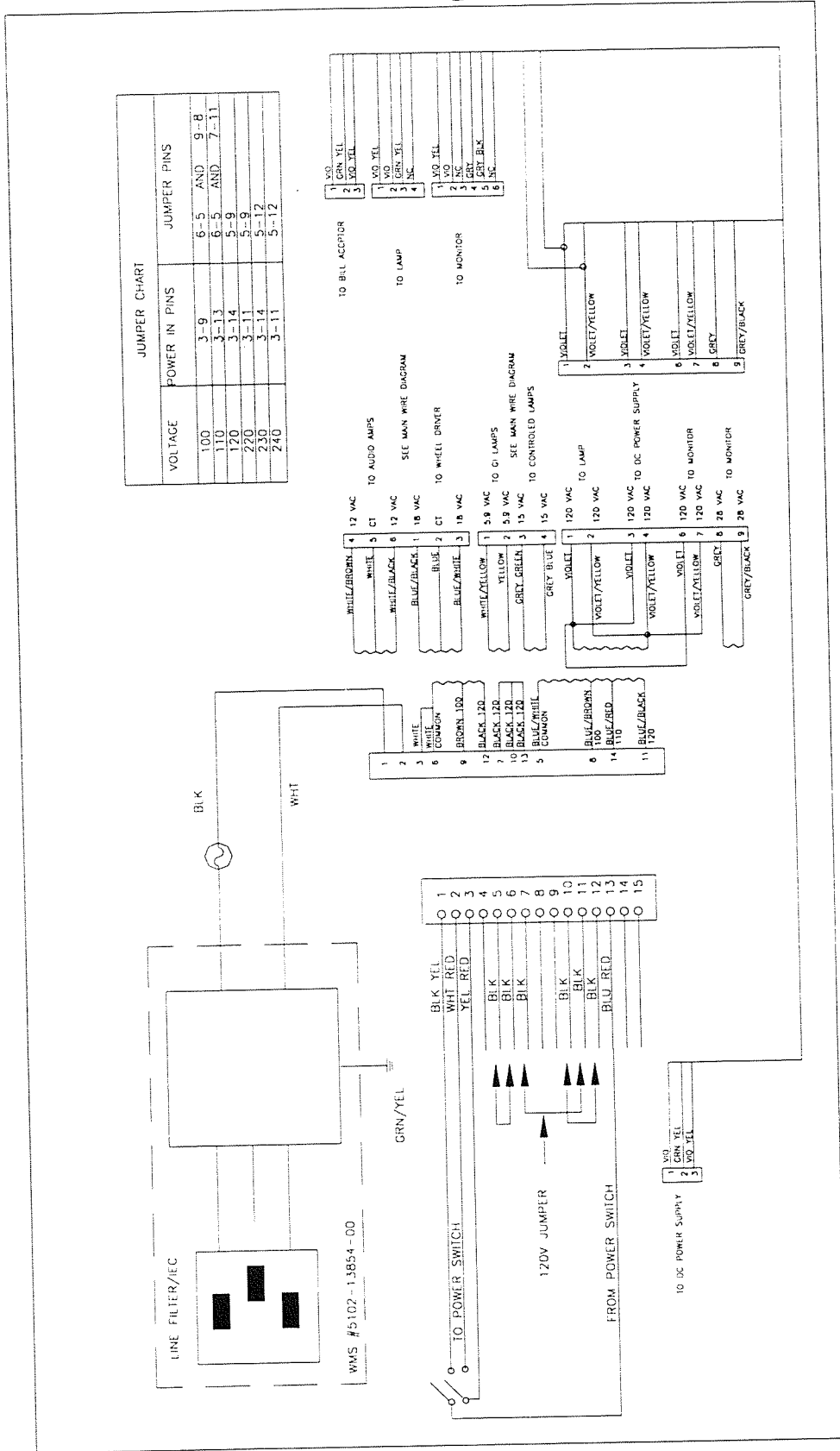

VOLTAGE	POWER IN PINS	JUMPER PINS
100	3-9	6-5 AND 9-8
110	3-13	8-5 AND 7-11
120	3-14	5-9
220	3-11	5-9
230	3-14	5-12
240	3-11	5-12

# CABINET WIRING DIAGRAM

